



# User Manual

## TRACE **2** Control

2-Parameter online Analyser



## TRACE **M4**

Extension to 4 Channels



## Technical Documentation TRACE C2 Control / M4

August 2019 - Version 008 -

### **Important Note:**

The data and information in this manual were compiled with the greatest of care. In spite of special care during creation of this document no warranty for an absolute accuracy can be given. If important information in this guidance are missed, if technical errors were found or if you would like to get more information about individual components, please notify us. Please direct your inquiry directly to TRACE Analytics GmbH.

TRACE Analytics GmbH  
Richard-Wagner-Straße 1  
38106 Braunschweig  
Germany  
E-mail: [info@trace.de](mailto:info@trace.de)  
[www.trace.de](http://www.trace.de)

All rights reserved. Reprint, also partly, not permitted

## Contents

Contents .....	3
Figures .....	8
Tables .....	10
1 About this document .....	11
1.1 Introduction .....	11
1.2 Validity .....	11
1.3 Target groups .....	12
1.4 Symbols used .....	12
2 Safety Instructions .....	13
2.1 Intended Use .....	13
2.2 Personnel Qualification .....	14
2.3 General Safety Instructions .....	14
2.3.1 Electrical Power .....	14
2.3.2 Energy Release .....	15
2.3.3 Accessories, Consumables and Spare parts .....	15
2.4 Personal Protective Equipment .....	16
3 Product description TRACE C2 Control / M4 .....	17
3.1 Principles of the electrochemical measuring technique .....	18
3.2 Biosensory principle .....	18
3.3 Fluidic and sampling .....	20
3.4 PID-Control .....	21
3.5 Data transmission and data saving .....	22
4 Scope of delivery .....	23
4.1 Equipment .....	23
4.2 Consumables .....	23
4.2.1 Tubing sets TRACE C2 Control .....	23
4.2.2 Tubing sets TRACE C2/M4 .....	23
4.2.3 Single-use dialysis probe .....	23
4.2.4 Enzyme reactor .....	24
4.2.5 Calibration standard solutions .....	24
4.2.6 Transport buffer .....	24
4.2.7 Disinfectants .....	25

4.2.8 Membranes.....	25
4.3 Sampling systems.....	26
4.3.1 Dialysis probe .....	26
4.3.2 Filtration probe .....	26
4.3.3 Bypass modules .....	26
4.4 Spare parts for the sampling systems .....	27
4.4.1 Spare parts dialysis probe.....	27
4.4.2 Spare parts filtration probe .....	27
4.4.3 Spare parts dialysis and filtration probe .....	27
4.4.4 Spare parts bypass modules .....	27
4.5 Spare parts for TRACE C2 Control and M4 .....	28
5 Design and function.....	29
5.1 Setting up the device .....	29
5.2 TRACE C2 Control Measurement Methods .....	33
5.2.1 Dialysis measuring method using the dialysis probe .....	34
5.2.1.1 Ancillary equipment M4 .....	35
5.2.2 Filtration measuring method using the filtration probe .....	36
5.2.2.1 Ancillary equipment M4 .....	36
5.2.3 Dialysis measuring method using the bypass module.....	37
5.2.3.1 Ancillary equipment M4 .....	39
5.3 Measurement cell function .....	40
5.4 Particle filter function .....	41
5.5 Diffusion module function .....	41
5.6 Dialysis probe function.....	42
5.7 Filtration probe function.....	43
5.8 Bypass module function .....	44
5.9 Enzyme reactor function .....	46
5.10 Temperature correction.....	46
6 Getting Started.....	47
6.1 Transport and Storage .....	47
6.2 Setup.....	47
6.2.1 Setting up the equipment .....	47
6.2.2 Preparation of transport buffer solution .....	48
6.2.3 Tubing on the device.....	49
6.2.4 Attaching the filtration tubing set .....	51



6.2.5 Attaching the tubing set for the „dialysis“ operating mode .....	56
6.2.5.1 Ancillary equipment M4 .....	56
6.2.6 Connection and removal of the enzyme reactor .....	58
6.2.7 Connecting the dialysis probe .....	60
6.2.7.1 Mounting the dialysis membrane in the dialysis probe .....	60
6.2.7.2 Installing the dialysis probe into the bioreactor .....	62
6.2.7.3 Installing the dialysis probe into a SU bioreactor .....	62
6.2.7.4 Sterilization of the dialysis probe .....	63
6.2.7.5 Connecting the dialysis probe to the tubing set .....	64
6.2.7.6 Cleaning the dialysis probe and replacing the membrane .....	65
6.2.8 Connecting the filtration probe .....	66
6.2.8.1 Hydrophilizing the polypropylene membrane .....	67
6.2.8.2 Leak test .....	67
6.2.8.3 Using the hydrophilization set .....	67
6.2.8.3.1 Description of the hydrophilizing set .....	68
6.2.8.3.2 Performing hydrophilization .....	68
6.2.8.3.3 Performing the leak test .....	69
6.2.8.4 Connecting the filtration probe to the tubing set .....	70
6.2.9 Connecting the bypass module .....	70
6.3 Loading the software and network connection .....	71
6.3.1 Connecting the ancillary equipment M4 .....	73
6.3.2 Troubleshooting .....	73
6.4 Installing the PC-software .....	74
6.5 Changing the start settings .....	75
6.5.1 Activate access restriction / Login .....	75
6.6 Assignment of analog outputs .....	76
6.6.1 Analog output C2 .....	76
6.6.2 Analog output C2/M4 .....	77
6.7 Device Startup .....	78
6.8 Decommissioning .....	78
7 Operation .....	79
7.1 Basic Commands .....	82
7.1.1 Start .....	82
7.1.2 Standby .....	82
7.1.3 Calibrate .....	82
7.1.4 Single Sample .....	82
7.1.5 Reference (for dialysis only) .....	82
7.1.6 Fast Reference (only for dialysis) .....	85

7.2 Menu bar .....	87
7.2.1 Menu item „Log“ .....	87
7.2.2 Menu item „Device“ .....	88
7.2.2.1 Connect.....	88
7.2.2.2 Setting-up operation .....	89
7.2.2.3 Cleaning .....	89
7.2.2.4 Stop.....	90
7.2.3 Menu item „Display“ .....	91
7.2.3.1 Print Diagram .....	91
7.2.3.2 Calibration values.....	91
7.2.3.3 Calibration history.....	92
7.2.3.4 Status .....	92
7.2.4 Menu item „Settings“ .....	93
7.2.4.1 Parameters.....	94
7.2.4.2 Test ports.....	98
7.2.4.3 Basic settings.....	99
7.2.4.4 Language .....	100
7.2.5. Menu item „Schedule“ .....	101
7.2.5.1 Edit Schedule.....	101
7.2.5.1.1 Events.....	101
7.2.5.1.2 Workflow.....	103
7.2.5.2 Autoreference (Dialysis mode only) .....	104
7.2.6 Menu item „Controller“ .....	105
7.2.6.1 PID-Controller.....	107
7.2.6.2 Minimum-Maximum-Controller .....	108
7.2.7 Menu item „Login“ .....	109
7.2.8 Menu item „Information“ .....	111
7.3 LED Status Messages .....	112
8 Tips and checklist .....	114
8.1 Choosing suitable standard solutions .....	114
8.2 Dialysis mode: Reference measurements at the start of fermentation .....	114
8.3 Dialysis mode: Reference measurements for low lactate concentrations.....	115
8.4 Avoiding contamination in the tubing set.....	115
8.5 Making best use of the enzyme reactor .....	116
8.6 Import data to Excel .....	118
8.6.1 Data transfer to excel using an excel macro.....	118
8.6.2 Manual data import to Excel .....	120
8.7 Checklist .....	123
9 Troubleshooting .....	125

9.1 Error messages .....	125
9.1.1 Calibration error .....	125
9.1.2 Calibration implausible.....	126
9.1.3 Sensor error .....	126
9.1.4 Error in control.....	126
10 Care and maintenance .....	129
10.1 Device.....	129
10.2 Tubing set cleaning.....	129
11 Disposal .....	131
11.1 General instructions .....	131
11.2 Hazardous Materials.....	131
12 Appendix.....	133
12.1 Technical documentation.....	133
12.2 Specifications (Technical data sheet).....	134
12.3 Additional Documentation .....	135
12.3.1 EC Declaration of Conformity .....	135
12.3.2 Decontamination Declaration .....	135
Index .....	136

## Figures

Figure 1: Enzymatic conversion of glucose .....	19
Figure 2: Enzymatic conversion of lactate .....	19
Figure 3: Enzymatic conversion of methanol / ethanol .....	19
Figure 4: Principle of the flow diffusion technique.....	20
Figure 5: Flow diagram to illustrate flow diffusion analysis .....	21
Figure 6: Front view TRACE C2 Control.....	29
Figure 7: Side view TRACE C2 Control .....	30
Figure 8: Rear view of TRACE C2 Control .....	31
Figure 9: TRACE C2 Control with stand clamp .....	32
Figure 10: TRACE C2 Control with table stand .....	32
Figure 11: C2 with M4 and table stand.....	32
Figure 12: Ready-for-use installation of TRACE C2 Control (filtration mode) .....	33
Figure 13: Flow diagram of the online dialysis method .....	34
Figure 14: Flow diagram of the 4-times dialysis method (with ancillary equipment M4) .....	35
Figure 15: Flow diagram of the online filtration method .....	36
Figure 16: Flow diagram of the online dialysis method with bypass module.....	37
Figure 17: Flow diagram of the 4-times dialysis method with bypass modules (with ancillary equipment M4) .....	39
Figure 18: Measurement cell .....	40
Figure 19: Diffusion module - schematic design.....	41
Figure 20: Fixation of the measurement cell.....	41
Figure 21: Functional principle of the dialysis probe.....	42
Figure 22: Filtration probe for sterile sampling from bioreactors .....	43
Figure 23: Bypass modules in stainless steel and PEEK .....	44
Figure 24: Configuration of the bypass module stainless steel .....	45
Figure 25: Enzyme reactor .....	46
Figure 26: View of a tubing set for the „Dialysis“ operating mode.....	49
Figure 27: View of fully-equipped front panel .....	51
Figure 28: Tightening and aligning of the pair of tubes in the guide plate .....	51
Figure 29: Position of the valve tubes on the device .....	52
Figure 30: Tightening and inserting the pair of tubes.....	52
Figure 31: Manually switching the valve to insert the rear tube securely. ....	52
Figure 32: Securing the valve tubes by pushing together the guide plates .....	53
Figure 33: Proper placement of the pump cassette (fastening stud locked in place).....	53
Figure 34: Attaching lower pump cassette P2 and upper pump cassette P1 .....	53
Figure 35: Fully assembled side panel.....	54
Figure 36: Inserting the measurement cell into the device .....	54
Figure 37: Fastening the measurement cell to the device.....	54
Figure 38: Fastening the diffusion module to the mounting rail .....	55
Figure 39: Inserting the drip counters into the holder .....	55
Figure 40: Place of installation for three-way stopcock (left), three-way stopcock + syringe mounted (right).....	56
Figure 41: Tubeset M4 - Overview.....	56
Figure 42: Special features in M4 tubeset .....	57
Figure 43: Selection valves M4 .....	57
Figure 44: Pumps M4.....	57
Figure 45: Critical point (arrow).....	57
Figure 46: Enzyme reactor .....	58
Figure 47: Request for installation of the enzyme reactor.....	58
Figure 48: Place of installation and securing the enzyme reactor .....	59
Figure 49: Replacing the membrane in the dialysis probe for the glucose / lactate application.....	60
Figure 50: Inserting a new membrane .....	61
Figure 51: Installation of the lunette.....	61
Figure 52: Tightening the 2 screws.....	61
Figure 53: Inserting the sliding ring and o-ring.....	62
Figure 54: Dialysis probe 300 mm with Kleenpak™ Adapter for use in SU bioreactors.....	62

Figure 55: Filling the dialysis probe with buffer solution .....	63
Figure 56: Sealing the probe prior to sterilization (autoclave loop) .....	63
Figure 57: Connecting the dialysis probe to the tubing set .....	64
Figure 58: Filtration probes in 12mm and 25 mm design .....	66
Figure 59: Hydrophilizing set with pump cassette and tubing lines .....	68
Figure 60: Setup and connection of the hydrophilizing set .....	68
Figure 61: Filtration start window with operating panel to control the pump for hydrophilizing .....	69
Figure 62: Filtration probe with tubing set / Connection of the filtration probe to the tubing set .....	70
Figure 63: Recommended PC settings for direct connection via crossover Ethernet cable .....	71
Figure 64: Login for network settings .....	72
Figure 65: Input field for network settings .....	73
Figure 66: Number of the device .....	73
Figure 67: Start settings .....	75
Figure 68: Analog outputs at the back side of the C2 device .....	76
Figure 69: Assignment of analog outputs on the C2/M4 .....	77
Figure 70: Start window indicating the selection and display ranges .....	79
Figure 71: Screen shot for adjusting the measured values display .....	80
Figure 72: Autostart .....	81
Figure 73: Screen display in "Standby mode" .....	81
Figure 74: Display after reference measurement .....	83
Figure 75: Prompt for sampling and connection to the three-way stopcock .....	84
Figure 76: Connecting the external sample .....	84
Figure 77: Correct position of the three-way stopcock .....	85
Figure 78: Display after fast reference .....	86
Figure 79: Menu option „Log“ .....	87
Figure 80: Menu option „Device“ .....	88
Figure 81: Connect device .....	88
Figure 82: Restart prompt window after „Stop“ .....	90
Figure 83: Menu option "Display" .....	91
Figure 84: Screen shot of current calibration values .....	91
Figure 85: Screen shot of current calibration history .....	92
Figure 86: Screen display of status bar .....	92
Figure 87: Menu option "Settings" .....	93
Figure 88: Entry screen for configuring the measurement parameters .....	94
Figure 89: Switching the analog output .....	96
Figure 90: Activating the serial protocol .....	96
Figure 91: Activating the OPC UA server .....	97
Figure 92: Selection/activation of ports and resulting displays .....	98
Figure 93: Test port selection fields .....	98
Figure 94: Entry screen for basic settings .....	99
Figure 95: Input mask for setting the IP addresses of peripheral devices. ....	100
Figure 96: Selection window for language settings .....	100
Figure 97: Menu item „Schedule“ .....	101
Figure 98: Example entry in the submenu „Events“ .....	101
Figure 99: Example entry in the submenu „Workflow“ .....	103
Figure 100: Input field for autoreference .....	104
Figure 101: Menu Options "Controller" .....	105
Figure 102: Setting for 4 controllers .....	105
Figure 103: Controller aktive (green) / inaktive (red) .....	105
Figure 104: Manual pump operation .....	106
Figure 105: Options in controller sub menu "Parameters" (left PID, right Minimum-Maximum) .....	107
Figure 106: Display options in PID-controller sub menu "Parameters" .....	107
Figure 107: Display options in Min-Max-controller sub menu "Parameters" .....	108
Figure 108: Min-Max-controller - Definition of Min- and Max-value .....	109
Figure 109: Min-Max-controller - Selection of control pump .....	109
Figure 110: Menu item „Login“ .....	109
Figure 111: Menu item „Information“ .....	111

Figure 112: Instructions for the use of the macro .....	118
Figure 113: Graphical overview of the experiment .....	119
Figure 114: Importing data from the bpd file into Excel. Activate „All files“ .....	120
Figure 115: Import data of the bpd file into Excel „Highlighting the bpd file“ .....	120
Figure 116: Import data from the bpd file into Excel, text conversion assistant step 1 .....	121
Figure 117: Import data from the bpd file into Excel, text conversion assistant step 2 .....	121
Figure 118: Import data from the bpd file into Excel, text conversion assistant step 3 .....	121
Figure 119: Import data of the bpd file into Excel „More text import options“ .....	122

## Tables

Table 1: Target groups .....	12
Table 2: Scope of delivery for TRACE C2 Control and TRACE M4 .....	23
Table 3: Consumables .....	25
Table 4: Sampling systems .....	26
Table 5: Spare parts for sampling systems .....	27
Table 6: Spare parts for TRACE C2 Control and TRACE M4 .....	28
Table 7: Consumption rate of transport buffer .....	48
Table 8: Overview of access rights .....	110
Table 9: LED status messages .....	112
Table 10: LED status messages ancillary equipment M4 .....	113
Table 11: Tabular overview of the experiment .....	118
Table 12: Sample data of a bpd file / method filtration glucose/lactate .....	122
Table 13: Checklist for Setting-up operation .....	124
Table 14: Problem description and troubleshooting .....	127
Table 15: Identifying and correcting calibration faults .....	128
Table 16: Technical data sheet TRACE C2 Control .....	134
Table 17: Technical data sheet TRACE M4 .....	134

## 1 About this document

### 1.1 Introduction

These instructions provide all the information necessary for operation of the TRACE C2 Control / TRACE M4 (hereinafter referred to as the device).

The instructions must be read, understood and used by all personnel using the device.

- These instructions are part of the device.
- Before working with the device, read the instructions carefully and completely.
- Keep them in a safe and easily accessible place near the devices site of installation.
- If the instructions are lost, request a replacement or download the latest instructions from our website.

### 1.2 Validity

These instructions apply to the online analyser TRACE C2 Control and TRACE M4. In general, these instructions describe the standard tasks for the TRACE C2 Control. Differences or deviating procedural steps for the TRACE M4 will be marked as such.

## 1.3 Target groups

These instructions are designed for the following target groups. The target groups must possess the knowledge listed.

Target group	Knowledge / Responsibilities
<b>User (Operator)</b>	The user is familiar with the operation of the device and the associated work processes. He knows the dangers that can occur when working with the device and can avoid these dangers. The user has been trained in the operation of the device. The training takes place within the scope of start-up and is carried out by the operating engineer/laboratory manager or the administrator of the device.
<b>Operating engineer/ laboratory manager (Responsible)</b>	The operating engineer/laboratory manager makes decisions about the use and parameterization of the device. The operating engineer/laboratory manager is trained in the operation of the device. The training takes places within the scope of start-up and is performed by TRACE Analytics GmbH or an authorized distributor.
<b>Administrator</b>	The administrator of the device is responsible for compliance with safety requirements and workplace safety regulations. The administrator must ensure that all persons who work with the device have access to the relevant information and have been instructed in work with the device.

Table 1: Target groups

## 1.4 Symbols used

The symbols used in the user manuals are specifically intended to draw attention to the safety precautions! The symbol may not replace the text of the respective safety precaution. Therefore, the text must always be read completely!



Indicates useful information and user tips



Warning of potential consequential damage



Warning of dangerous electrical voltage



Warning of materials that are health hazards or irritants

Failure to follow the safety instructions in this manual can have serious consequences, e.g. exposure of individuals to electrical, mechanical or chemical hazards.



## 2 Safety Instructions

The devices were designed and built under consideration of hazard analyses, additional technical specifications and according to a meticulous selection of harmonized standards to be complied with. It is thus a state-of-the-art device that ensures the highest degree of safety.

However, this safety can only be achieved during practical operation when all the necessary measures are applied. It is the operator's responsibility to plan these measures and monitor their execution.

The following safety instructions do not release the operator from the duty to observe other relevant safety measures which apply to the respective equipment.

### 2.1 Intended Use

The device is a 2-channel online analyser used to determine Glucose/ L-Lactate, Methanol or Ethanol in laboratory or industrial cultivations of microorganisms and cell lines.

TRACE M4 is an additional device for TRACE C2 Control to enlarge the number of measuring channels.

In particular, the operator must ensure that the devices

- are used for its intended purpose only, see chapter "3 Product description TRACE C2 Control / M4" and are used only when functional and in proper working order.
- are only be used indoors, standing on a level, horizontal surface (Figure 9) respectively mounted at a stand (Figure 10) and
- the user manuals are always kept legible and complete at the place of use.

#### Foreseeable Misuse

Any use beyond the intended use of the device e.g.

- operation outside the permissible ambient conditions, e.g. extreme temperatures, chemical vapours, moisture, shock, vibration or strong electromagnetic fields
- carrying out unauthorized modifications or other technical changes on the device
- connecting unsuitable devices
- installation of unauthorized items on the device

can cause severe unforeseeable hazards and is the sole responsibility of the administrator.

## 2.2 Personnel Qualification

All persons working on the device must possess the necessary knowledge (see chapter "1.3 Target groups").

The activities described in these instructions are aimed at the target group of operators. If individual actions must be carried out by other target groups, this will be indicated.

## 2.3 General Safety Instructions

Failure to follow the safety instructions in this manual can have serious consequences, e.g. exposure of individuals to electrical, mechanical or chemical hazards.

- Before starting up the device: Carefully read the chapter "2 Safety Instructions".
- Only operate the device when it is safe and in perfect working order.
- Observe the maintenance intervals (chapter „10 Care and maintenance“).
- Have any damage repaired immediately by a service personnel of TRACE Analytics respectively of the authorized distributor.

### 2.3.1 Electrical Power

Electrical switching elements are installed in the device. Damage to the insulation or individual components can be life-threatening. Contact with parts under voltage represents a direct danger of death.

Work on and modifications to the electrical equipment of the device may only be carried out by service personnel of TRACE Analytics respectively of the authorized distributor.

The device may only be opened by service personnel of TRACE Analytics respectively of the authorized distributor.

- Check the device regularly for defects, such as loose connections or damage to the insulation. The device's housing, power cord and all connections must be undamaged.
- Note the device's protection class (IP rating). The protection class specifies the suitability of equipment for various ambient conditions, e.g. moisture or foreign bodies (see chapter "12.2 Specifications (Technical data sheet)").
- Make sure that the power connection is equipped with a ground lead.
- Do not use inadequately sized power cords.
- Keep live parts away from moisture. Moisture can cause short circuits.
- If the electrical equipment is defective, immediately turn off the power supply and contact the service personnel of TRACE Analytics respectively of the authorized distributor.

### 2.3.2 Energy Release

Energy supply lines may be incorrectly dimensioned and **not** protected against impermissible fluctuations and faults. This can lead to energy being released e.g. electric surges.

The power supplies used to operate the device must be designed in accordance with the technical data (see chapter "12.2 Specifications (Technical data sheet)"). Energy connections must be fitted with fully functional safety equipment:

- Earth leakage circuit breaker for mains connections (ground fault circuit interrupter).

### 2.3.3 Accessories, Consumables and Spare parts

The use of unsuitable accessories, consumables and spare parts can be hazardous:

- Damage to the device
- Malfunction of the device
- Total failure of the device.

	<ul style="list-style-type: none"><li>• Only use accessories, consumables and spare parts from TRACE Analytics.</li><li>• Only use accessories, consumables and spare parts that are in technically perfect condition.</li></ul>
--	--

TRACE Analytics GmbH can provide information on operational quality upon request.

The use of accessories, consumables and spare parts **not** approved by TRACE Analytics is the sole responsibility of the operator.

### Conduct in an Emergency

Malfunction may result in injury or property damage.

If there is immediate danger of personal injury or equipment damage, take the device out of operation immediately:

- Unplug the power cord from the device.
- Have any malfunctions repaired immediately by the service of TRACE Analytics respectively of the authorised distributor.

The solutions (buffer concentration, cleaning and calibration solution) used for the operation of the devices are not acidly, poisonous or seriously harmful to skin. If there is any skin contact with the solutions rinsing with water is sufficient. You can find more information on this in the safety data sheet for each solution.

## 2.4 Personal Protective Equipment

### **Protective work clothing**

Protective work clothing is tight-fitting work clothing with low tear resistance, tight sleeves and without any projecting parts.

- Suitable protective clothing must be worn. For example, it is intended to protect you from being caught by moving parts.
- Do not wear rings, chains or other jewelry.

To protect yourself from potential dangers personal protective equipment (e.g. protection goggles, laboratory gloves) shall be worn.

Also follow any instructions posted in the work area pertaining to personal protective equipment, hygiene and disinfection.

### 3 Product description TRACE C2 Control / M4

TRACE C2 Control is a 2-channel online analysis system used to determine Glucose / L-Lactate, Methanol or Ethanol. Its applications cover both microbial fermentation processes as well as the cultivation of animal or human cell lines. The ancillary equipment M4 can monitor up to four reactors.

When analyzing substrates in cultivation media, it is necessary for a sample to be removed from the bioreactor (fermenter) under sterile conditions. The reproducibility and relevance of the sample taken must remain intact during this step.

The device currently features the following sampling options:

Filtration probe and dialysis probe. All systems enable sterile removal from the bioreactor

The device consists of a compact housing that is adapted to the application and ambient conditions. All mechanical and fluid elements are arranged on the front and / or on the side panels. The electronics feature a modular design and are configured to communicate through several interfaces.

Analysis is carried out using a sensor unit consisting of an electrochemical biosensor. System control and data analysis are run on an external computer. The control software included is very easy-to-use.

Additionally to its analytical performance The device provides a direct feed control. Therefore the device is equipped with an internal PID-controller and an integrated feed pump. For direct feed of larger bioreactors conventional external pumps can be connected via the serial or analog port.

The M4 is an extension of the TRACE C2 Control with the option to monitor up to four different bioreactors. The M4 integrates 4 additional pumps and four 3/2-way valves into the fluidics so that four sampling probes can be operated in parallel. The desired probe is then selected by means of the additional valves. The controller function for the 4-port module can be provided on request.

The measurement range of the device extends from 0.1 to 40 g/l for glucose, from 0.05 to 10 g/l for lactate, from 0.5 to 20 g/l for methanol and from 1 to 40 g/l for ethanol.

Depending on the conditions, the measurement frequency is 60 analyses per hour maximum. Due to its structured design and easy-to-operate concept, the user can perform routine analysis functions after just a brief introduction.

The ambient temperature of the device can range between 15 and 35°C due to internal temperature correction. The ambient humidity shall not exceed 90%.

Analysis in the device is a combination of enzymatic conversion and electrochemical detection. A 2-channel enzyme electrode coated with oxidase or a combination of an

enzyme reactor with a platinum electrode (methanol/ethanol application) serves as the biosensor.

Depending on the application, the service life of the sensor system ensures 30 days or 5000 measurements. The deviation from the average measurement is less than 1.5% for a measurement of 2 g/l glucose and 1 g/l lactate.

### 3.1 Principles of the electrochemical measuring technique

An electrochemical detector measures the current produced at a specific potential applied to the electrodes by the analytes in a flow measurement cell. In the presence of an electrolyte solution, the electrochemical conversion of the substance at the working electrode leads to the release or attraction of electrons (oxidation or reduction). The size of the measurable threshold current depends on the parameters of Faraday's law of electrolysis as well as on Fick's diffusion law and is proportional to the concentration.

The selectivity of the sensitive detector is based on the principle that not all substances are electrochemically active and thus many extraneous substances in a sample solution will not be detected. Selectivity is dependent on the working electrode's material and the applied potential.

By combining this system with enzymes, the selectivity of an electrochemical sensor can be raised even higher – and the electrode is turned into a biosensor.

### 3.2 Biosensory principle

The analytes glucose and lactate are detected by means of enzymatic reactions. Figure 1 shows the enzymatic conversion of glucose to gluconolactone. In the presence of water, gluconolactone is immediately hydrolyzed to gluconic acid. The hydrogen peroxide ( $H_2O_2$ ) produced in the first step is detected amperometrically through anodic oxidation that releases the two electrons. Figure 2 shows the enzymatic conversion of lactate to pyruvate. During this reaction as well,  $H_2O_2$  is formed and then detected amperometrically.

Enzyme reactions take place according to the "key-lock principle". They are specific and thus highly selective. Therefore, the reaction at the enzyme system is a further selection. The combination of the two selective principles makes the Device largely insensitive to matrix effects and extraneous materials.

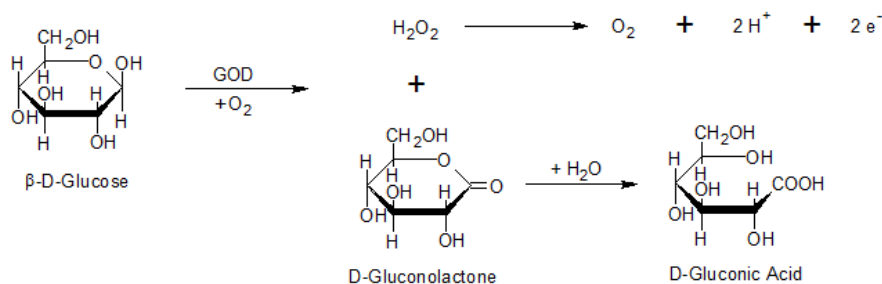

Figure 1: Enzymatic conversion of glucose

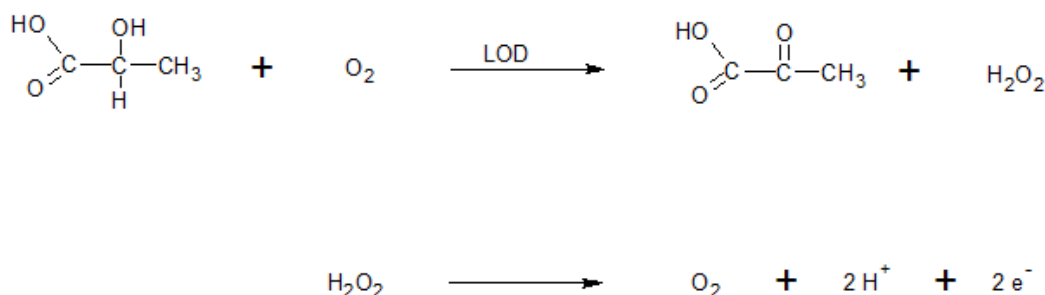

Figure 2: Enzymatic conversion of lactate

The TRACE biosensors consist of platinum thick-film electrodes that are durably coated with the corresponding enzymes (glucose oxidase (GOD) or lactate oxidase (LOD)). Then, enzyme and electrode are in close proximity to each other, so that the reactions described above can be recorded directly.

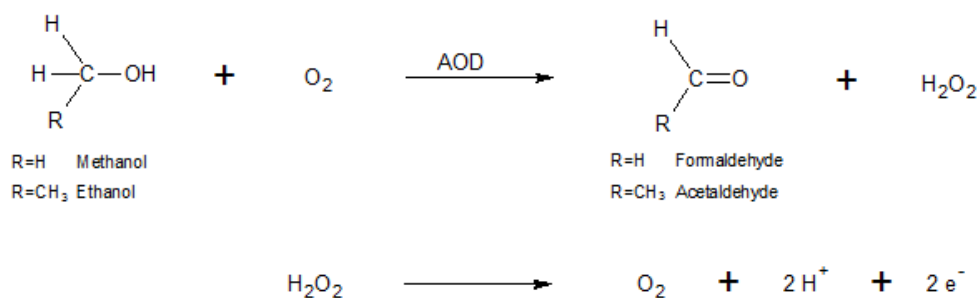

Figure 3: Enzymatic conversion of methanol / ethanol

Figure 3 shows the enzymatic conversion of methanol or ethanol to formaldehyde or acetaldehyde. The enzyme alcohol oxidase (AOD), which occurs in an enzyme reactor in immobilized form, is used as catalyst. The hydrogen peroxide (H<sub>2</sub>O<sub>2</sub>) formed in the reaction is detected amperometrically. With this method, the alcohol is converted in the enzyme reactor and the detection of the formed hydrogen peroxide takes place on a platinum electrode.

### 3.3 Fluidic and sampling

To perform the respective analysis on a sample, representative material must be transported to the biosensor. A fluidic system (tubing set) consisting of tubing lines, pumps and valves is used for that purpose. Additionally, the sample is also conditioned in the fluidic system, i.e. potentially interfering components are removed, and diluted to the extent that it can be assayed reliably by highly sensitive biosensors. This is done by separation through a dialysis membrane, which is integrated in every tubing set as a diffusion module.

Conditioning of the sample is based on the method of flow diffusion analysis (Figure 4).

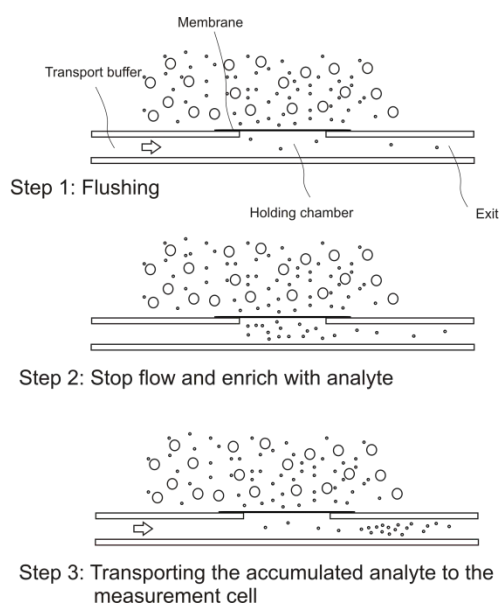

This method works with a time-dependent sample transfer. For that purpose, the measurement line and the sample and / or the sample infeed are separated from each other by a membrane. The measuring line is called the acceptor (receiving) and the sample side is called the donor (giving).

During an analysis, the measurement line is flushed with a transport buffer, which is an acceptor stream that can be stopped from behind the membrane for a defined period of time. This procedure is carried out by triggering a valve, which in turn opens up by a bypass route as shown in Figure 5.

Figure 4: Principle of the flow diffusion technique

Meanwhile, the analytes in the sample diffuse through the membrane and, at the same time, are enriched in the holding chamber. In this way, a continually increasing concentration of dialyzable components develops in the fluid segment of the transport buffer.

When this segment is released by re-triggering the valve, the flow goes to the measurement cell where it generates a signal. The intensity of the signal is a measure of the concentration of the sample. One big advantage of this enrichment method is the very broad measuring range that is achieved by varying the diffusion time; it also protects the sensor against interfering particles in the sample.



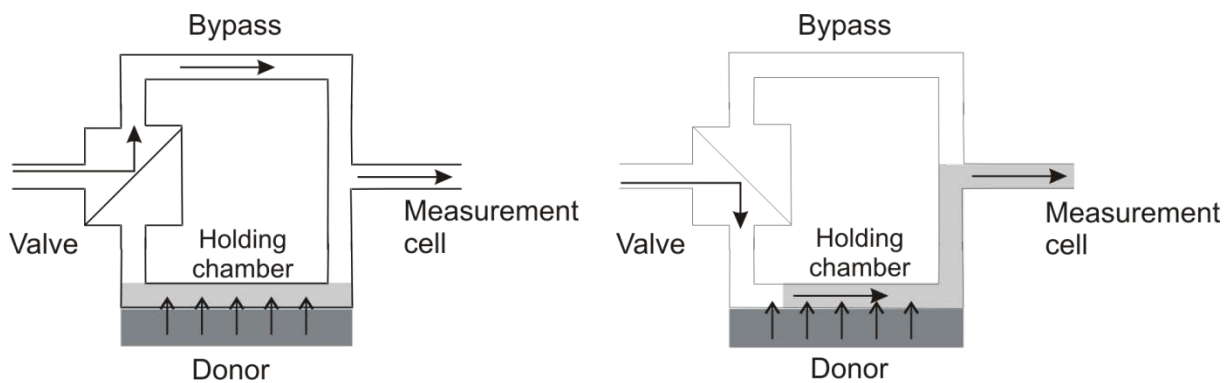

Figure 5: Flow diagram to illustrate flow diffusion analysis

Image on the left: Valve control during the determination of the baseline and while loading.

Image on the right: Valve control while unloading and during signal detection.

### 3.4 PID-Control

Feeding in a cultivation can be reliably controlled with the integrated PID-controller. The PID-controller consists of three interacting single controller. These are the proportional controller (**P**), the integral controller (**I**), and the derivative controller (**D**). The control action of the controller is described by a differential equation:

$$u(t) = K_P \times e(t) + \frac{K_P}{T_N} \times \int_0^t e(\tau) d\tau + K_P \times T_V \frac{d}{dt} e(t)$$

The persistent control deviation of the proportional gain of the controller can be balanced with the integral gain. With the derivative gain of the controller it is possible to react to fast changes of concentrations inside the reactor. The PID-controller is better suited for feeding processes than a simple two-level controller.

#### Adjusting the PID-Controller

The principle of the PID-controller is known since 1922 (Minorsky<sup>[1]</sup>), but useful rules for adjustment were not available since 1942 (Ziegler and Nicols<sup>[2]</sup>). Today most of the controller will be adjusted by empirical design. This design can also be used in the field of biotechnology.

#### Literature

[1] Minorsky, Nicolas: Directional stability of automatically steered bodies; J. Amer. Soc of Naval Engineers 34 (1922), pp. 280–309.

[2] Ziegler, J.G. and Nicols, N.B.: Optimum settings for automatic controllers; Trans. ASME, 64 (1942), pp.759-768

### 3.5 Data transmission and data saving

The device has a number of outputs, making integration into data recording systems very flexible. Along with a standard analog output for signal ranges from 0 to 20mA, 0 to 10 V or 4 to 20mA, the Device also features an Ethernet connection that connects the device to a PC via a network.

Using the supplied trace\_mon software, the device is configured, controlled and the measurement results are graphically displayed and stored (see chapter "7 Operation").

The measured data are displayed in the trace\_mon diagram and additionally recorded as text in a bpd-file. This file is saved in the default subdirectory „Data“.

If the network connection between the device and the PC is interrupted, the data in the device will be buffered until a connection is restored. The missing data is then automatically transferred to the trace\_mon software.

## 4 Scope of delivery

### 4.1 Equipment

Description	Part no.
Device TRACE C2 Control with power adapter, power plug, cross-over ethernet cable, user manual and PC-Software (trace_mon)	141.000.000
Device TRACE M4 with power adapter, power plug, Ethernet switch, Ethernet cable 3 m, 2x Ethernet cable 0.25 m, user manual and PC-Software (trace_mon)	144.000.000

Table 2: Scope of delivery for TRACE C2 Control and TRACE M4

### 4.2 Consumables

#### 4.2.1 Tubing sets TRACE C2 Control

Description	Part no.
Tubing set dialysis glucose/lactate	130.200.000
Tubing set dialysis glucose/lactate/low	130.200.003
Tubing set filtration glucose/lactate	130.200.001
Tubing set filtration glucose/lactate/cellulase resistant	130.200.002
Tubing set dialysis ethanol/methanol	130.200.020
Tubing set filtration ethanol/methanol	130.200.021
Feeding pump 1.0 with barb adapter for tubing up to ID 1.6 mm	130.200.100
Feeding pump 2.5 with barb adapter for tubing up to ID 2.5 mm	130.200.110

#### 4.2.2 Tubing sets TRACE C2/M4

Description	Part no.
Tubing set dialysis glucose/lactate	130.200.400
Tubing set dialysis glucose/lactate/low	130.200.403
Tubing set dialysis ethanol/methanol	130.200.420

#### 4.2.3 Single-use dialysis probe

Description	Part no.
Single-use dialysis probe	860.400.010

#### 4.2.4 Enzyme reactor

Description	Part no.
Enzyme reactor for application ethanol/methanol	811.100.120

#### 4.2.5 Calibration standard solutions

Content: 0.5 liter

Description	Part no.
Calibration standard 0.1 g/l glucose, 0.05 g/l lactate	850.305.006
Calibration standard 0.5 g/l glucose, 0.25 g/l lactate	850.305.000
Calibration standard 1 g/l glucose, 0.5 g/l lactate	850.305.001
Calibration standard 2 g/l glucose, 1 g/l lactate	850.305.002
Calibration standard 4 g/l glucose, 2 g/l lactate	850.305.003
Calibration standard 10 g/l glucose, 5 g/l lactate	850.305.004
Calibration standard 20 g/l glucose, 10 g/l lactate	850.305.005
Calibration standard 0.2 g/l methanol	850.301.002
Calibration standard 1 g/l methanol	850.301.004
Calibration standard 5 g/l methanol	850.301.005
Calibration standard 20 g/l methanol	850.301.008
Calibration standard 0,5 g/l ethanol	850.302.004
Calibration standard 2 g/l ethanol	850.302.001
Calibration standard 4 g/l ethanol	850.302.002
Calibration standard 40 g/l ethanol	850.302.005

#### 4.2.6 Transport buffer

Description	Part no.
Transport buffer concentrate 20x (for cell cultivations), application glucose/lactate; content: 0.5 liter	850.300.135
Transport buffer concentrate 5x (for microbial cultivations), application glucose/lactate; content: 1 liter	850.300.102
Transport buffer concentrate 5x, application methanol ethanol; content: 1 liter	850.300.613

#### 4.2.7 Disinfectants

Description	Part no.
Cleaning solution (glucose/lactate), ready to use, content: 1 liter	850.300.710
Cleaning solution (ethanol/methanol), ready to use, content: 1 liter	850.300.711

#### 4.2.8 Membranes

Description	Part no.
Membranes (glucose/lactate) dialysis probe (5 pcs)	860.211.049
Membranes (glucose/lactate/cellulase resistant) dialysis probe (5 pcs)	860.211.043
Membranes (glucose/lactate/low measuring range) dialysis probe (5 pcs)	860.211.045
Membranes (glucose/lactate/low immersion depth) dialysis probe (5 pcs)	860.211.080
Membranes (ethanol/methanol) dialysis probe (5 pcs)	860.211.036
Membrane for the filtration probe, length 130 mm	860.300.330
Membrane for the filtration probe, length: 90 mm	860.300.331
Membranes (glucose/lactate) bypass module stainless steel/PEEK measuring range 0.5 – 40 g/l (5 pcs)	860.211.050
Membranes (glucose/lactate/low) bypass module stainless steel/PEEK measuring range 0.1 – 5 g/l (5 pcs)	860.211.046

Table 3: Consumables

## 4.3 Sampling systems

### 4.3.1 Dialysis probe

(Delivery with installation kit, 2 membranes and user manual)

Description	Part no.
Dialysis probe length: 132 mm	860.202.510
Dialysis probe length: 165 mm	860.202.520
Dialysis probe length: 212 mm	860.202.530
Dialysis probe length: 232 mm	860.202.540
Dialysis probe length: 300 mm	860.202.545
Dialysis probe length: 332 mm	860.202.550
Dialysis probe length: 362 mm	860.202.560
Dialysis probe length: 432 mm	860.202.570

### 4.3.2 Filtration probe

(Delivery with 1 membrane and user manual)

Description	Part no.
Filtration probe / cover port 12 mm with compression fitting PG 13.5, membrane length 130 mm	860.300.300
Filtration probe / cover port 12 mm with compression fitting PG 13.5, (insertion depth extended by 100 mm), membrane length 130 mm	860.300.301
Filtration probe / cover port 12 mm with compression fitting PG 13.5, (insertion depth extended by 250 mm), membrane length 130 mm	860.300.302
Filtration probe / side port 25 mm with shut-off cock, membrane length 130 mm	860.300.320
Filtration probe / side port 25 mm with shut-off cock, membrane length 90 mm	860.300.321

### 4.3.3 Bypass modules

(Delivery with installation kit, 2 membranes and user manual)

Description	Part no.
Bypass module stainless steel, 3-part diffusion block with 2 barbed tubing adapter for I.D. 6 mm and I.D. 9 mm	860.202.001
Bypass module PEEK, 2-part diffusion block with 2 pump tubing adapter for tubing I.D. up to 2 mm	860.202.002

Table 4: Sampling systems

## 4.4 Spare parts for the sampling systems

### 4.4.1 Spare parts dialysis probe

Description	Part no.
Installation kit dialysis probe	809.100.130
Adapter UNF/LUER male and female for the installation kit dialysis probe (5 pcs)	809.100.132
Autoclave Loop UNF/UNF for the installation kit dialysis probe (5 pcs)	809.100.133
Adapter 25/12 mm for the installation of the 165 mm dialysis probe in 25 mm side port (Ingold port 52 mm) incl. o-rings	860.301.001
Dialysis probe lunette -0.20 mm (Application Ethanol/Methanol)	860.203.050

### 4.4.2 Spare parts filtration probe

Description	Part no.
Tubing set for the hydrophilization of filtration membranes	130.200.150
Blind plug (Locking the filtration probe)	816.000.150
Membrane protective cage for the filtration probe with membrane length 130 mm, installation in 25 mm side port (Insertion depth extended by ca. 25 mm)	860.300.350
Membrane protective cage for the filtration probe with membrane length 90 mm, installation in 25 mm side port (Insertion depth extended by ca. 25 mm)	860.300.351

### 4.4.3 Spare parts dialysis and filtration probe

Description	Part no.
Compression fitting PG13.5 with o-ring and sliding ring	860.300.012
Adapter 19/12 mm for the installation of the dialysis and filtration probe in 19 mm cover port (M26x1) incl. o-rings	860.300.016
Adapter 19/12 mm for the installation of the dialysis and filtration probe in 19 mm cover port (RD28x1/8") incl. o-rings	860.300.017

### 4.4.4 Spare parts bypass modules

Description	Part no.
Installation kit for bypass module stainless steel	809.100.135
Installation kit for bypass module PEEK	809.100.136

Table 5: Spare parts for sampling systems

## 4.5 Spare parts for TRACE C2 Control and M4

Description	Part no.
Table stand	730.000.010
Stand clamp	730.000.000
Knurled screw (replacement for the measurement cell)	137.000.031
Power adapter	200.005.050
Power plug (EU, UK or USA)	200.005.051

Table 6: Spare parts for TRACE C2 Control and TRACE M4



## 5 Design and function

### 5.1 Setting up the device

The device is an online analysis system in a compact metal housing. Communication with the user is driven by an external computer. As shown in Figure 6 and Figure 7, the front and side panels are equipped with the elements of the pre-assembled tubing set for analysis.

The actuator and sensor components are located on the outside of the housing. A standard or sample solution is fed into the analysis system by a pump (1 b). One of the pinch valves (3) allows a selection of the solutions to be pumped.

The buffer stream is driven by the upper pump (1 a). A particle filter (2) removes smaller particles and air bubbles from the buffer stream.

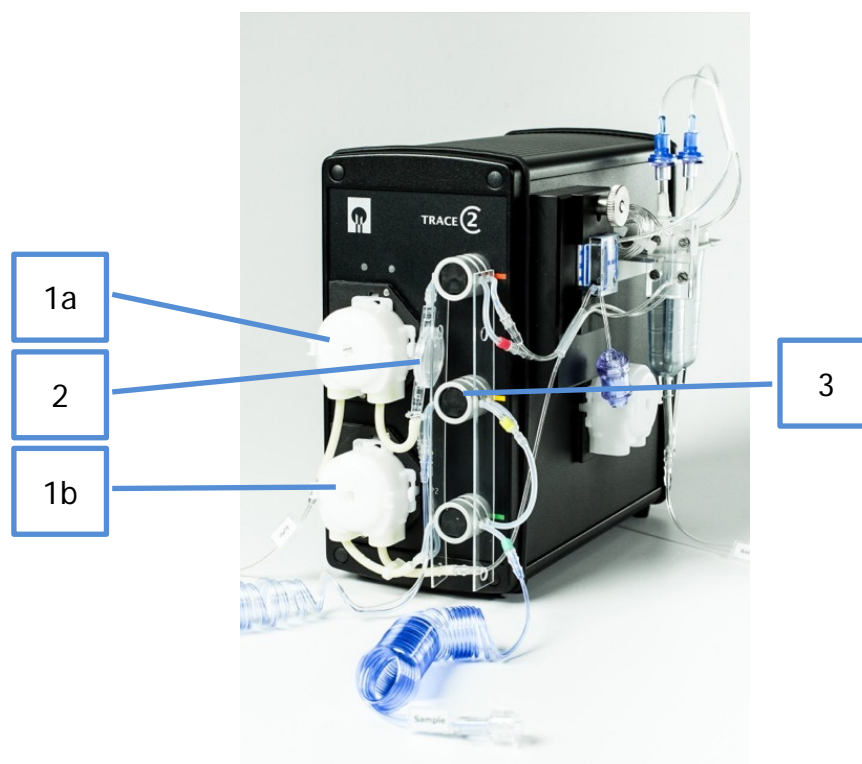

Figure 6: Front view TRACE C2 Control

Pos.	Component
1a,b	Pump cassettes (2 pieces)
2	Particle filter
3	Pinch valves (3 pieces)

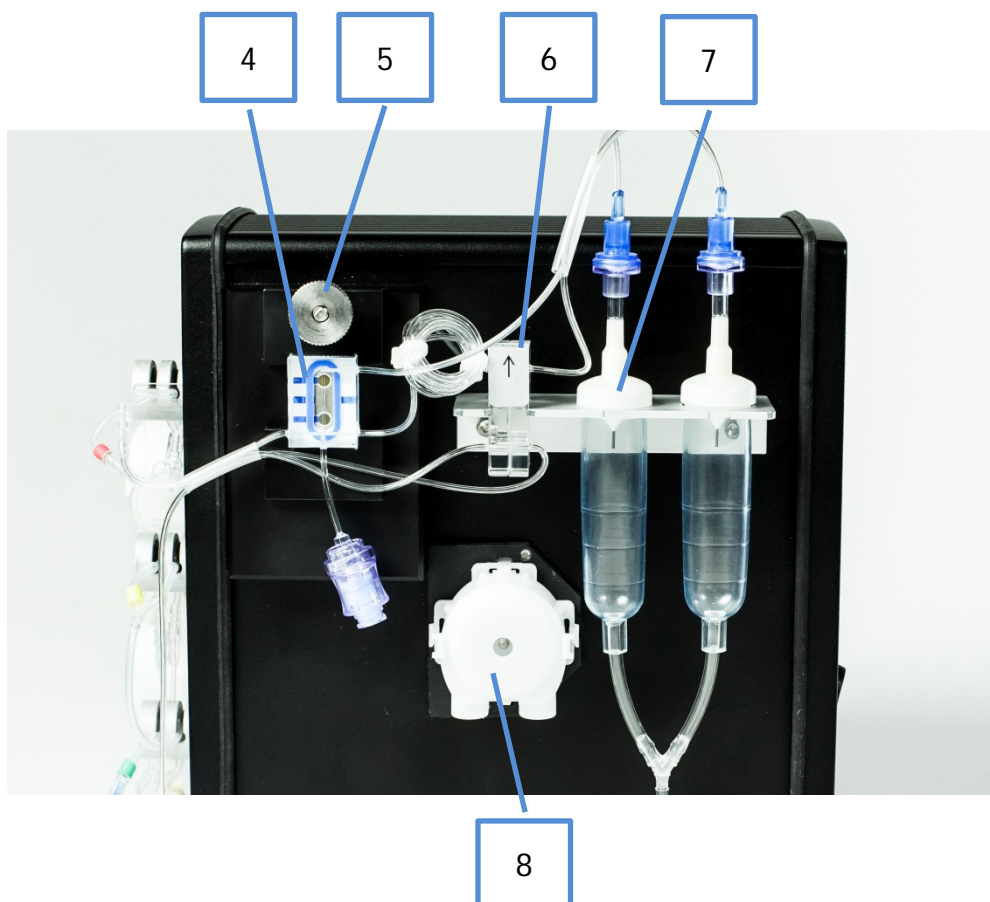

Figure 7: Side view TRACE C2 Control

Pos.	Component
4	Measurement cell
5	Knurled screw for fastening the measurement cell
6	Diffusion module
7	Drip counters
8	Feed pump

In the diffusion module (6), a segment of the buffer solution is enriched with the analyte from the donor stream. After time-dependent enrichment in the diffusion module (6), the acceptor stream flows into the measurement cell (4) for assaying the analyte. The measurement cell is fixated by a retaining plate, which can be fastened or loosened with a knurled screw (5). Before the solutions are transported to waste, they run through a drip count (7).

The integrated feed pump (8) is located below the diffusion module.

Figure 8 shows the rear view of TRACE C2 Control. The device can be switched on and off by pressing the power switch (10).

Using the calibration data, the electrochemical signal of the biosensor is converted internally to a concentration value. The measured value is output after the analysis is completed on a PC interfaced to the Ethernet connection (11). Optionally, the signals can be output via the analog signal output (13). The following ranges are possible: 0..10 V, 0..20 mA, 4..20 mA. The USB interface (12) and the serial interface RS232 (14) can also be used for data transfer.

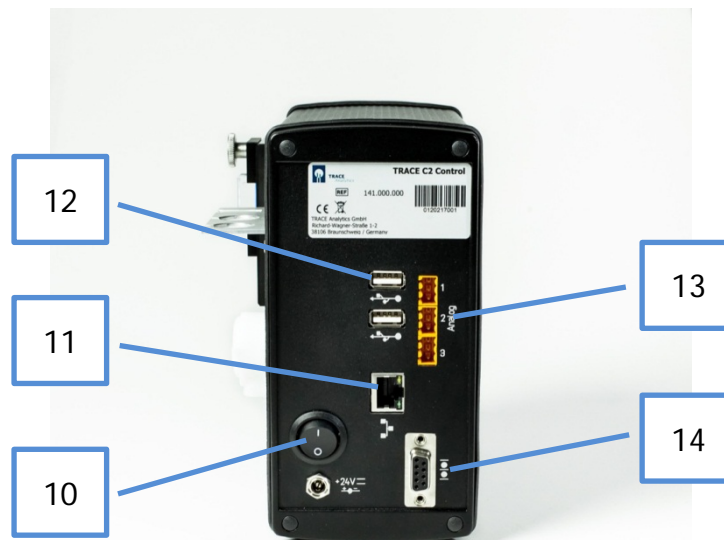



Figure 8: Rear view of TRACE C2 Control

Pos.	Function
10	Power switch
11	Ethernet connection
12	USB interface
13	Analog outputs (1-3)
14	Serial interface

	<p>Under no circumstances shall a voltage source be connected to the analog data outputs at the back of The device. This also refers to a multimeter for resistance measurement.</p> <p>If a multimeter is used to measure the voltage or current, the contacts to the device must be removed before changing the measurement range on the multimeter. Otherwise, there is the danger that the device will be damaged.</p>
---	--

TRACE C2 Control and M4 can be optionally attached to laboratory stands, handrails or table stands. A stand clamp and a table stand are available as accessories. Thus, the system can be replaced in a space-saving manner on laboratory benches near the bioreactors.



Figure 9: TRACE C2 Control with stand clamp

For an expansion of the TRACE C2 with the M4 peripheral device, a table stand is required in any case, so that the tubing set for the 4-channel measurement can be fitted functionally.



Figure 10: TRACE C2 Control with table stand



Figure 11: C2 with M4 and table stand

## 5.2 TRACE C2 Control Measurement Methods

Three online measurement methods are possible with the device:

- Filtration with a filtration probe,
- Dialysis with a dialysis probe,
- Dialysis with a Bypass module.

The simplest method is to directly measure a filtered sample of medium. However, because reactor medium is used, the range of applications is limited to processes for which there's a sufficient reactor volume or which allow continuous-feed.

Dialysis sampling is an option when processes are involved for which reactor volume does not allow enough sample material.

This method only removes low molecular substances from the reactor medium, without reducing the volume of fluid.

For example, Figure 12 shows a ready-for-use installation in filtration mode.

A more detailed explanation of the sampling probes can be found in chapters

- "5.6 Dialysis probe function"
- "5.7 Filtration probe function"
- "5.8 Bypass module function"



Figure 12: Ready-for-use installation of The device (filtration mode)

### 5.2.1 Dialysis measuring method using the dialysis probe

The dialysis measuring method using the dialysis probe involves the transfer of analytes through a dialysis membrane in the dialysis probe which separates the reactor contents (medium) from the acceptor stream. At the same time, the dialysis membrane functions as a sterile barrier.

Figure 13 shows a schematic of the flow system.

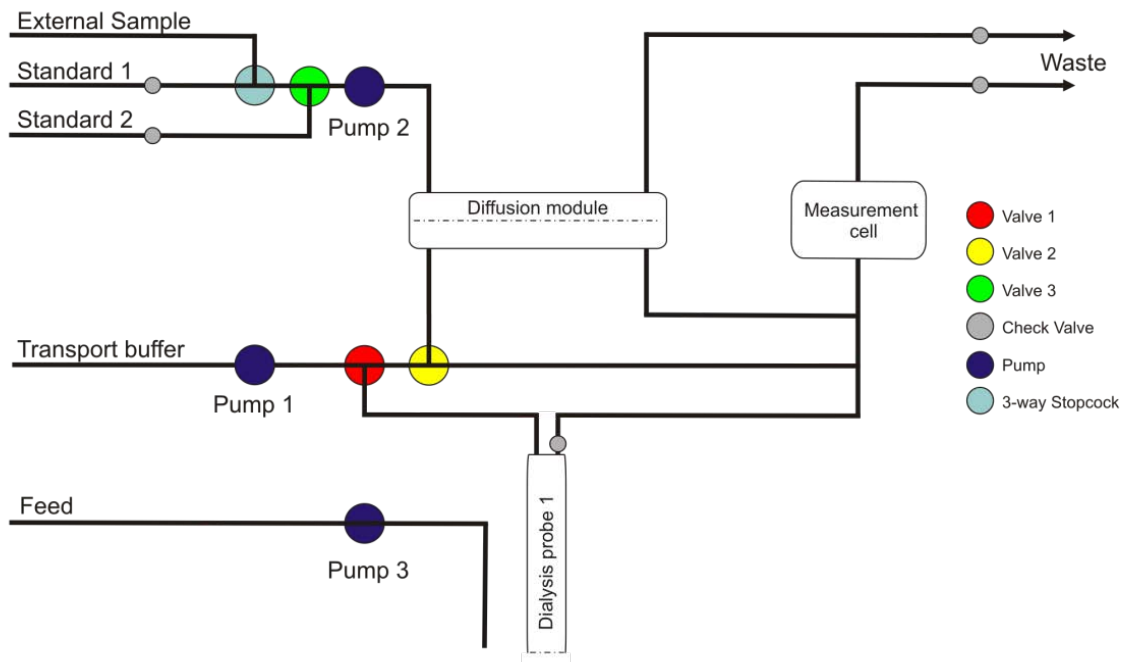

Figure 13: Flow diagram of the online dialysis method

The upper part of the flow diagram represents the donor stream, which is responsible for the infeed of the calibration solution or an external (manual) sample into the diffusion module. The calibration valve (green) selects between the two different standards.

In the lower part of the flow diagram the transport buffer is used as the acceptor stream, which accumulates the analytes depending on the position of the valves either in the diffusion module or in the dialysis probe. The sample valve (red) and the bypass valve (yellow) are used to switch between dialysis probe and diffusion module.

Pump 3 performs the feeding when the controller is activated.

For the dialysis method, the internal diffusion module is used to calibrate the device. By contrast, the dialysis probe in the bioreactor is always used for measuring the sample. A reference factor between the membranes is then determined once. As a standard cannot be installed in the bioreactor, The device must be calibrated indirectly by way of the reference factor. During this process, the initial concentration in the bioreactor is used as the starting concentration for the dialysis probe. Using the sample measurement values with an identical concentration, the device



calculates the factor between the diffusion module membrane and the dialysis probe membrane.

Hence, the calibration procedure for the dialysis method consists of three steps in total:

- Step 1: Recording the calibration curves on the diffusion module with standard 1 and standard 2.
- Step 2: Measuring the external sample on the device with the help of the calibration curves (alternatively: by directly entering the concentration values, if known from the initial weight or by external analysis).
- Step 3: Recording the calibration curves of the dialysis probe using the probe.

After measuring the standards for calculating the calibration curves, the device computes a factor from the gradients of each individual curve.

For all measurements carried out with the dialysis probe, this factor is applied to calculate the true concentration.

#### 5.2.1.1 Ancillary equipment M4

With the aid of M4 the dialysis method can be performed at up to 4 bioreactors. The sample pumps 1-4 flush the probes continuously. The selecting valves at the side of the device are used for the individual selection of dialysis probe 1-4 (Figure 14).

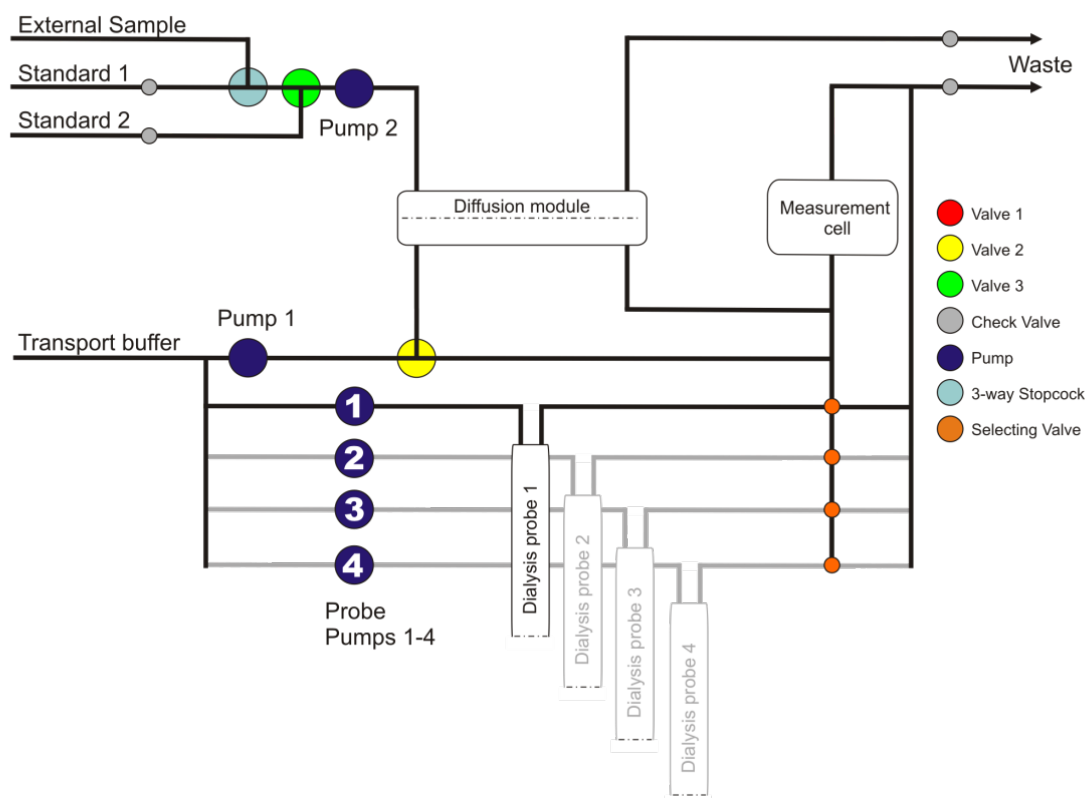

Figure 14: Flow diagram of the 4-times dialysis method (with ancillary equipment M4)

## 5.2.2 Filtration measuring method using the filtration probe

With the filtration measuring method, the samples are drawn from the bioreactor through the filtration probe. Pump 2 withdraws the filtrate into the diffusion module, where the diffusion of analytes takes place and transfers them into the stream of transport buffer.

The calibration valve (yellow) and the sample valve (green) are used to select between the calibration solutions and the filtration probe. The bypass valve (red) is used to select the diffusion module and the bypass. Pump 3 performs the feeding when the controller is activated.

Figure 15 shows a schematic of the flow system.

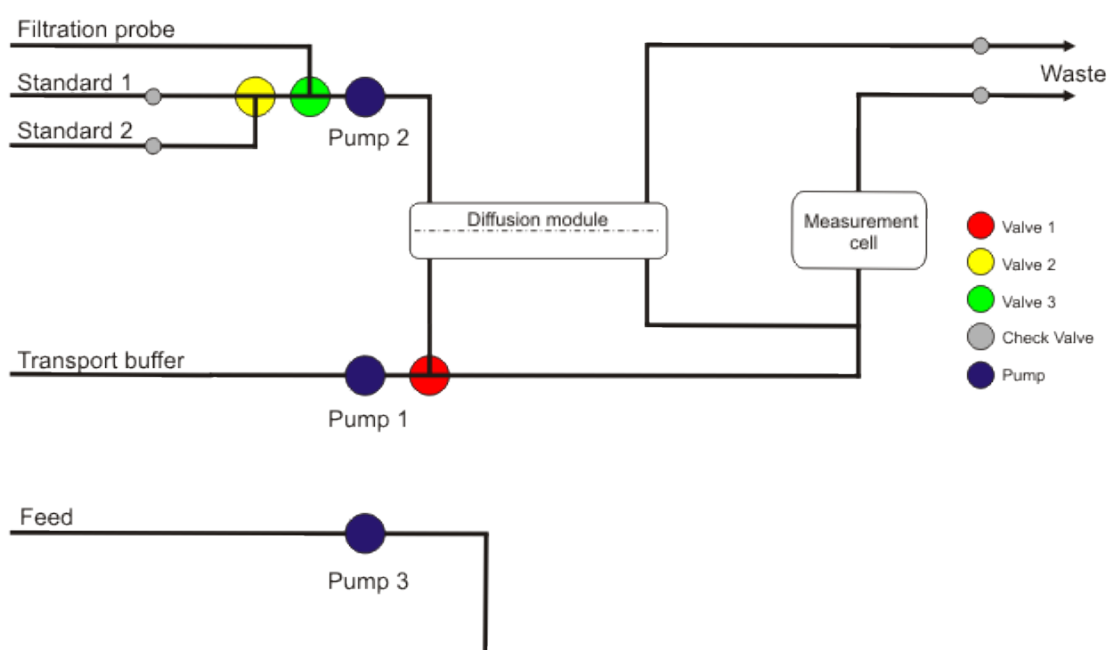

Figure 15: Flow diagram of the online filtration method

With the online filtration method, the diffusion module is always used for calibrating the device and for measuring samples. The device calculates the regression curve including zero point and gradient from multiple measurements of calibration standards 1 and 2. In turn, the sample concentration is calculated based on the calibration curves.

### 5.2.2.1 Ancillary equipment M4

The filtration method is not yet available for use with the M4



### 5.2.3 Dialysis measuring method using the bypass module

The TRACE bypass dialysis module is recommended for perfusion cultures and in cases where in-situ sampling with probes is not possible. The bypass module is installed as a part of the perfusion tubing manifold outside of the bioreactor. It is especially recommended for online sampling in cell cultures. Dialysis based sampling with the bypass module proceeds in the same way like the method with the dialysis probe. In this case the membrane used for analyte separation is located externally from the bioreactor inside the bypass module.

The dialysis measuring method using the bypass module involves the transfer of analytes through a dialysis membrane in the bypass module which separates the reactor contents (medium) from the acceptor stream. At the same time, the dialysis membrane functions as a sterile barrier.

Figure 16 shows a schematic of the flow system.

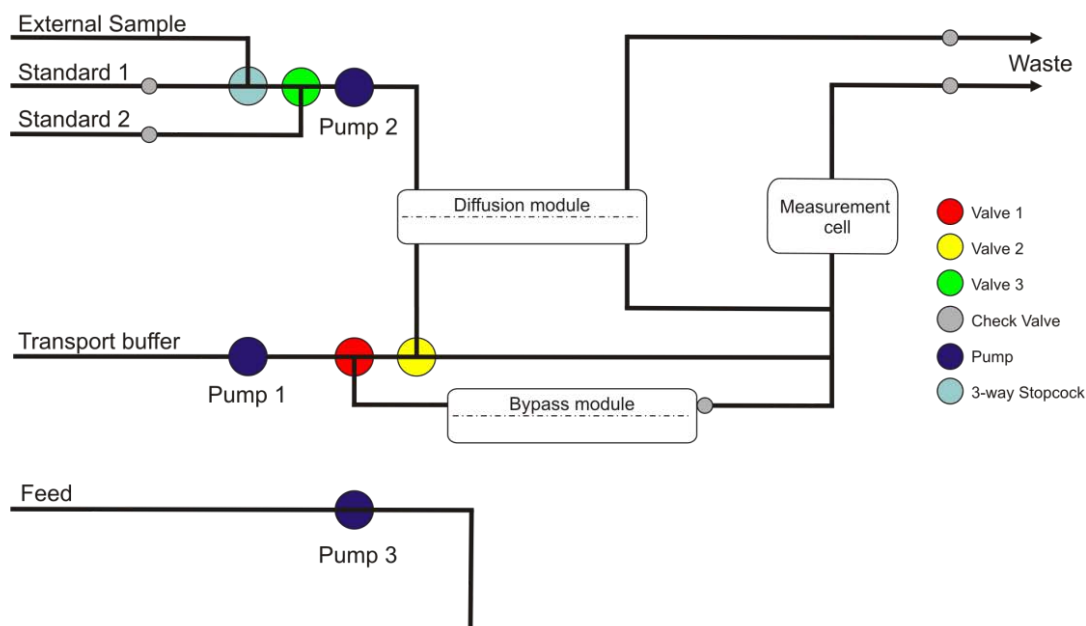

Figure 16: Flow diagram of the online dialysis method with bypass module

The upper part of the flow diagram represents the donor stream, which is responsible for the infeed of the calibration solution or an external (manual) sample into the diffusion module. The calibration valve (green) selects between the two different standards.

In the lower part of the flow diagram the transport buffer is used as the acceptor stream, which accumulates the analytes depending on the position of the valves either in the diffusion module or in the bypass module. The sample valve (red) and the bypass valve (yellow) are used to switch between bypass module and diffusion module.

Pump 3 performs the feeding when the controller is activated.

For the dialysis method, the internal diffusion module is used to calibrate the device. By contrast, the bypass module in the bioreactor-bypass is always used for measuring the sample. A reference factor between the membranes is then determined once.

As a standard cannot be installed in the bioreactor-bypass, The device must be calibrated indirectly by way of the reference factor. During this process, the initial concentration in the bioreactor is used as the starting concentration for the bypass module.

Using the sample measurement values with an identical concentration, the device calculates the factor between the diffusion module membrane and the bypass module membrane.

Hence, the calibration procedure for the dialysis method consists of three steps in total:

- Step 1: Recording the calibration curves on the diffusion module with standards 1 and 2.
- Step 2: Measuring the external sample on the device with the help of the calibration curves (alternatively: by directly entering the concentration values, if known from the initial weight or by external analysis).
- Step 3: Recording the calibration curves of the bypass module using the probe.

After measuring the standards for calculating the calibration curves, the device computes a factor from the gradients of each individual curve. For all measurements carried out with the bypass module, this factor is applied to calculate the true concentration.

### 5.2.3.1 Ancillary equipment M4

With the aid of M4 the dialysis method can be performed at up to 4 bioreactors. The sample pumps 1-4 flush the modules continuously. The selecting valves at the side of the device are used for the individual selection of module 1-4 (Figure 17).

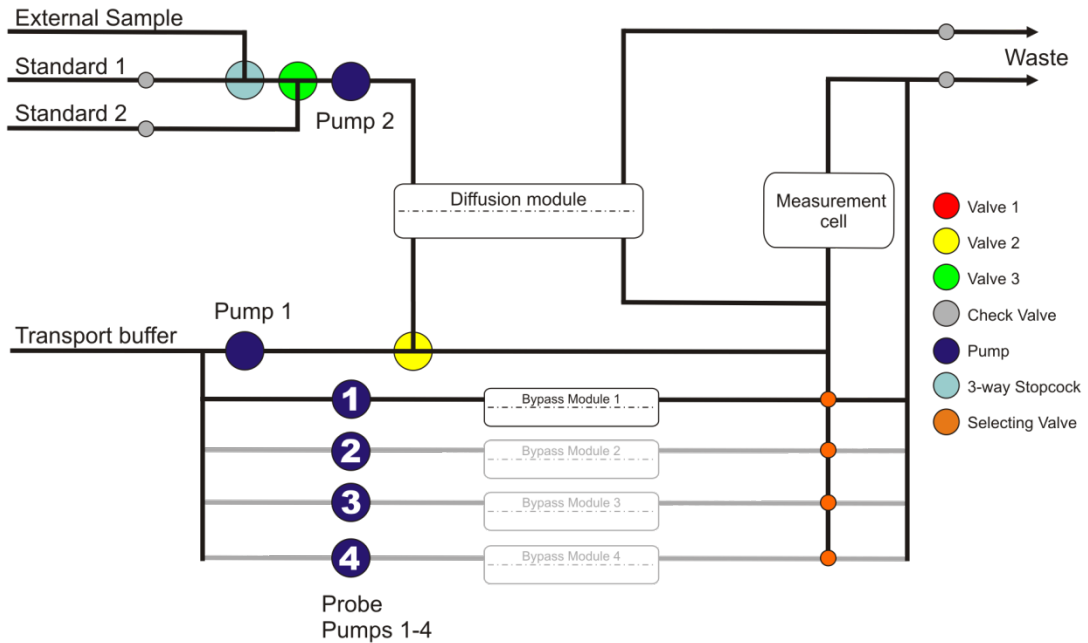
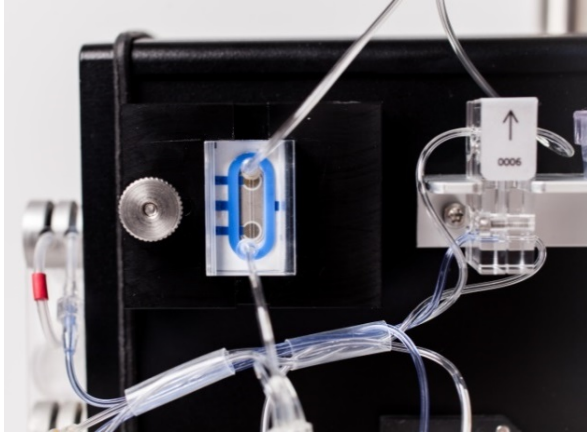

Figure 17: Flow diagram of the 4-times dialysis method with bypass modules (with ancillary equipment M4)

## 5.3 Measurement cell function

The measurement cell contains biosensors for glucose and lactate, respectively methanol/ethanol. The measurement cell is shown in Figure 18.



The fluid inlet flow runs perpendicular to the 2-channel sensor („wall jet“ principle). A viewing window allows the operator to monitor the air bubble-free flow through the cell.

Contact springs intercept the electrical signal measurable at the electrodes and transmit it to the device.

The measurement cell is fastened to the device with a knurled screw.

Figure 18: Measurement cell

	<p>It must be ensured that no air bubbles are in the measuring chamber of the flow cell, as these can influence the results.</p> <p>After connecting the sampling probe and before starting each measurement series, check the measurement cell for air bubbles through the viewing window.</p>
--	---

Basically, air bubbles in the tubing set are rinsed out over time. However, this process takes some time (e.g., during the priming process). If air bubbles are present in the measuring cell after the connection of the dialysis probe, it would be advantageous to operate the system with a maximum measuring frequency for a duration of approx. 30 minutes.

	<p>If air bubbles are present in the measuring cell, under no circumstances should calibrations or referencing be carried out, as they may be faulty and consequently lead to incorrect results.</p>
---	--

## 5.4 Particle filter function

The particle filter is part of the tubing set. It fulfills two tasks in the device. First, sterile filtration of the buffer solution is performed through the membrane with a pore size of 0.22  $\mu\text{m}$ . Before the solution leaves the module, a second membrane is used for degassing. Thus, the particle filter ensures that the acceptor stream in the device stays free of particles and air bubbles.

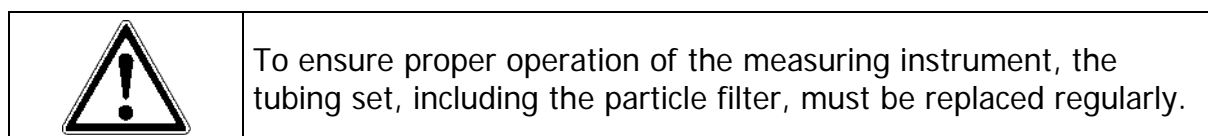

## 5.5 Diffusion module function

The diffusion module is part of the tubing set. The standard solutions or an external sample are pumped through the diffusion module to the analysis system.

A membrane enables diffusion of the substrate from the donor solutions (both standard and sample) into the buffer solution (acceptor). The different membrane materials enable dialysis, cellulase-stable dialysis and gas diffusion for separating substrates. Figure 19 shows a schematic diagram of this system.

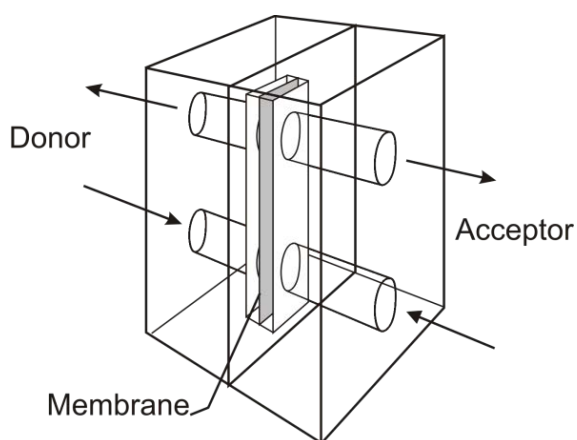

Figure 19: Diffusion module - schematic design

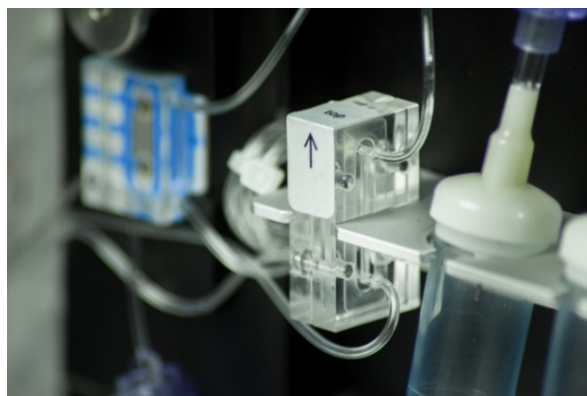
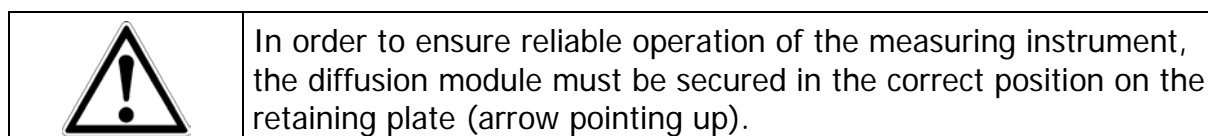

Figure 20: Fixation of the measurement cell

The module is made of PMMA. It has a diffusion area of 20  $\text{mm}^2$  and ensures that a sufficient exchange of substances takes place between the donor and the acceptor stream. The donor and acceptor streams flow in through the lower module inlet. The drain is located at the top.



## 5.6 Dialysis probe function

If a dialysis probe is used to feed the sample from the bioreactor into the device, then the analyte is transferred through a diffusion membrane into an internal pump-driven buffer stream and transported to the measurement cell.

Figure 21 shows the principal function of how the probe works.

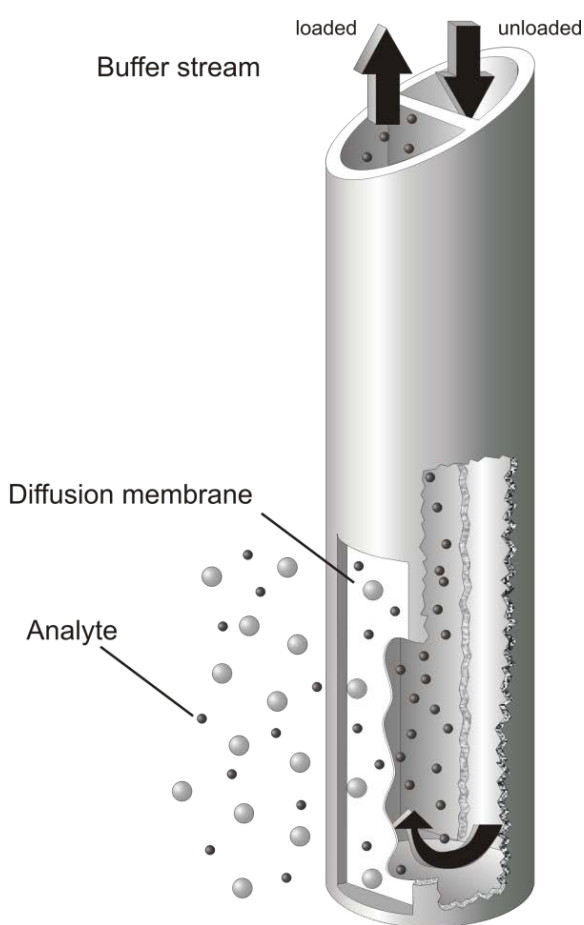

The dialysis probe is suitable for all types of cultivation. The use of an extremely robust diffusion membrane ensures a high level of sterility.

The different membrane materials enable dialysis, cellulase-stable dialysis and gas diffusion for separating substrates. The probe can be installed in the bioreactor as well as in the cover or in a side nozzle as well.

The application options for the dialysis probe depend on the reactor dimensions and the process conditions.

In general, the dialysis probe is recommended for use on smaller bioreactors, where any loss of volume during sampling is unacceptable. The use of the dialysis probe as a sampling system ensures analysis at constant volumes.

Figure 21: Functional principle of the dialysis probe

Optimal results can only be achieved if the membrane is completely immersed. Therefore, a minimum immersion depth of 5 cm is required.

In addition to the standard membrane, there are special membranes available:

- Cellulase resistant membrane for media where cellulases are released during the process
- Gas diffusion membrane for samples with volatile components (e.g. methanol and ethanol)
- For small bioreactors (<200 ml) with low immersion depth of the dialysis probe (2.5 cm).

## 5.7 Filtration probe function



Figure 22: Filtration probe for sterile sampling from bioreactors

Cell-free substrate samples are removed from the bioreactor using the sampling probe on a filtration basis (Figure 22). The hydrophilized probe is mounted inside the bioreactor and subsequently sterilized along with the medium. The membrane module of the probe is positioned in the turbulent zone of the reactor, near the agitator. A tubular membrane made of polypropylene serves as a sterile barrier. The filtrate flux does not exceed 2 ml/min.

After sampling, the cell-free sample can be fed directly into the device for analysis. The filtration probe is used when a sufficient reactor volume is available.

## 5.8 Bypass module function

The TRACE bypass dialysis module is an alternative to the dialysis probe. It is frequently used for perfusion cultures and in other cases where in-situ sampling with probes is not possible. The bypass module is installed as a part of the perfusion tubing manifold outside of the bioreactor.

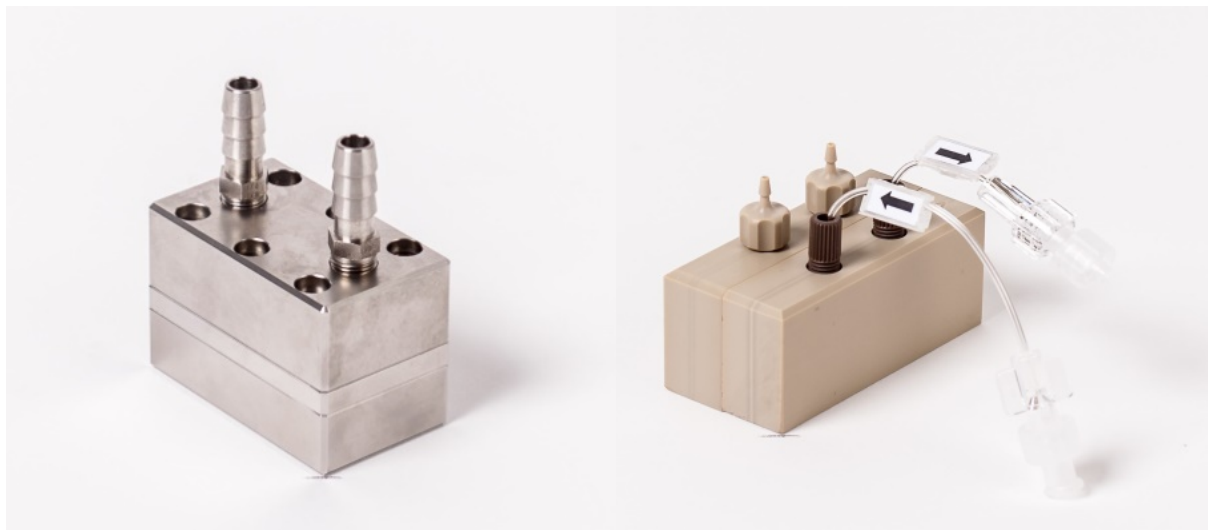

Figure 23: Bypass modules in stainless steel and PEEK

The bypass module PEEK consists of 2 blocks which can be easily fixed and sealed by allen screws. The front block is forming the donor-channel, which connects the flowing stream of reactor medium with the dialysis membrane. The rear block serves as the acceptor-channel and fixes the dialysis membrane with the front block.

The dialysis membrane creates a sterile barrier between the two channels and permits diffusion of the analyte into the acceptor stream. The bypass module PEEK is prepared with 2 pump tubing adapters for tubing I.D. up to 2 mm and two O-rings for the additional sealing of the adapter.

The bypass module PEEK is used for low volume flow rates of the donor stream.

The bypass module stainless steel consists of three blocks which can be easily fixed and sealed by Allen screws (see Figure 24). The front block and the middle block are forming the donor-channel, which connects the flowing stream of reactor medium with the dialysis membrane. The rear block serves as the acceptor-channel and fixes the dialysis membrane with the middle block. The dialysis membrane creates a sterile barrier between the two channels and permits diffusion of the analyte into the acceptor stream.



Two barbed tubing adapters for tubing I.D. 6 mm or I.D. 9 mm are used for the connection with the donor stream and UNF analytical fittings are used for the connection of the analyser manifold.

The bypass module stainless steel is used for larger volume flow rates of the donor stream.

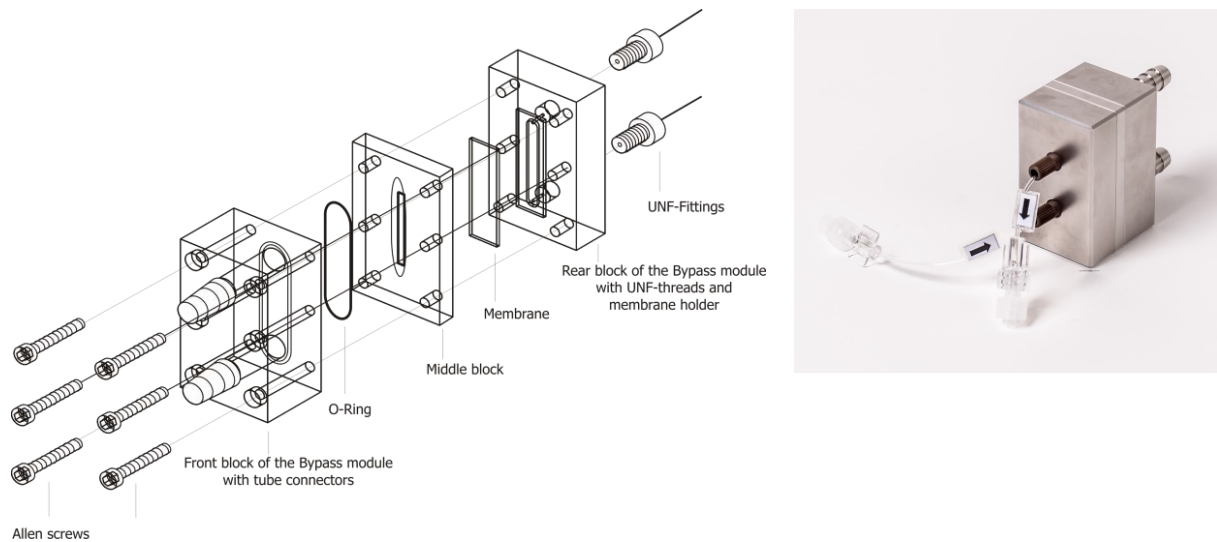

Figure 24: Configuration of the bypass module stainless steel

## 5.9 Enzyme reactor function



Figure 25: Enzyme reactor

The enzyme reactor is required for measuring methanol and ethanol (Figure 25). Inside the reactor is the immobilized enzyme alcohol oxidase (AOD). There, the corresponding alcohol is converted and hydrogen peroxide is formed. The hydrogen peroxide is then detected in the measurement cell.

## 5.10 Temperature correction

The device is equipped with a temperature sensor. This is arranged in the proximity of the measurement cell. All measured values are corrected by using a temperature-dependent function.

## 6 Getting Started

### 6.1 Transport and Storage

The device including accessories is delivered in protective packaging.

- Please save this packaging; proper (return) shipping is only possible in the original packaging.
- Upon receipt, check the delivery for completeness and any possible damage that may have occurred in transit.
- Any transport damage must be reported within a week of delivery. Complaints made after this date will not be accepted.

If the device is not set up immediately after delivery, or will temporarily not be used, the following conditions of storage must be observed:

	<p><b>Risk of damage due to improper storage!</b> Only store the device in dry buildings and do not leave the device outdoors.</p>
---	--

### 6.2 Setup

#### 6.2.1 Setting up the equipment

The device must be setup near the bioreactor you wish to monitor (at max. distance of 2 m). The location must be free of vibrations and protected against corrosive atmospheres and chemical contamination. Additionally, the device must be protected against exposure to direct sunlight.

	<p>Follow the instructions and requirements listed below concerning the power connection. Operating the equipment with the wrong supply voltage and / or the wrong fuses can be life-threatening.</p>
---	---

The AC adapter supplied with the device is equipped with a power plug, a mains adapter and a plug to the device. Insert the device plug into the connection socket on the back panel of the device and connect the other end to your mains outlet. The device can be switched on and off by pressing the power switch.

When switching on the instrument the left LED turns green. During the boot phase the right LED shines white. Table 9 in chapter "7.3 LED Status Messages", page 112, gives an overview about the color codes of the LED´s in different situations.

To connect the device to the local network, plug the Ethernet cable into the Ethernet connection on the back panel of the device. The operating software supplied is used to control the device via a PC. Likewise, this PC must also be connected to the local network or directly to the device using the cross-over Ethernet cable supplied.

After connecting the device to the PC, check to make sure that the system times of the two units are synchronized. Proceed as described in chapter "7.2.4.3 Basic settings".

## 6.2.2 Preparation of transport buffer solution

Transport buffer solution is shipped as a concentrate and has to be diluted with water (deionized or distilled) prior to use. Proper dilution can be checked by conductivity measurement of an aliquot. The diluted transport buffer shall have a conductivity of 5 – 15 mS/cm.

In order to prevent contaminations in the tubeset it is advisable to sterile filter the diluted transport buffer and/or fill it in sterile containers such as bottles or bags. Precautions to prevent contaminations in the tubeset are summarized in "8.4 Avoiding contamination in the tubing set".

	<p>The transport solution is delivered as concentrate. Observe the note for proper dilution on the packaging. Incorrect or no dilution will lead to erroneous measuring values!</p>
---	---

The consumption of transport buffer is dependent on the measurement intervall and the number of test ports in operation. For a typical single channel measurement in the dialysis mode the following consumption can be expected (Table 7):

Dialysis mode					
Intervall	Buffer Consumption			10 L for:	
min	µl/min	ml/h	ml/d	h	d
1	835,6	50,1	1203,2	199	8
5	835,6	50,1	1203,2	199	8
10	614,4	36,9	884,7	271	11
20	356,3	21,4	513,1	468	19
30	270,3	16,2	389,3	617	26
60	184,3	11,1	265,4	904	38
120	141,3	8,5	203,5	1179	49
180	127,0	7,6	182,8	1313	55
360	112,6	6,8	162,2	1480	62

Table 7: Consumption rate of transport buffer

If using the M4 the volumes have to be multiplied with the number of test ports used.



Before filling tubing set, make sure that tubing is connected to all solutions and that the vessels are sufficiently filled. Tubing sets that are only partially filled or not filled at all can produce erroneous measurements!

### 6.2.3 Tubing on the device

Depending on the type of operation intended, the device is equipped with corresponding tubing sets (fluidics).

For each of these types of operation, you will find below the corresponding instructions for attaching the tubing set.

The corresponding tubing set consists of the components necessary for analysis: Pump cassettes, valve tubes, measuring chamber, diffusion module, drip counters and connection lines for buffers, standards, waste as well as the sampling probe (filtration, dialysis).



The lines for buffers, standards, sampling probe and waste are pre-mounted and packaged in foil bags. It is recommended to only open these after the tubing set has been attached to the device in order to facilitate handling.



Figure 26: View of a tubing set for the „Dialysis“ operating mode

In addition, the dialysis tubing set is provided with a single-use syringe with three-way stopcock for the analysis of external samples.

Before you start attaching, remove the empty cassettes on the pump slots. The empty cassettes can be reused as transport protection for the motor axle.

	Only use tubing from the prefabricated original tubing set. To ensure that all solutions flow freely, never allow the tubing segments to be crushed or kinked.
	Make sure that the valve tubes are firmly seated in their pinch valves in order to ensure that the tubing can be opened and closed without problems.

The inlet and outlet lines of the tubing set are packaged in foil bags and labeled. The individual tubes are affixed with the following labels:

- BUFFER      Connect to the transport buffer
- WASTE      Connect to waste
- ←      Probe port 1 dialysis
- →      Probe port 2 dialysis
- Sample      Probe port filtration
- Standard1      Cover label for standard calibration solution 1
- Standard2      Cover label for standard calibration solution 2

The tubing sets for applications with the M4 have additional labels for the connection of the respective probes 1-4.

## 6.2.4 Attaching the filtration tubing set

Before attaching the filtration tubing set, the valve tubes must first be inserted into the pinch valves.

To keep them from getting mixed up, each line is color-coded. The following rules apply:



Figure 27: View of fully-equipped front panel for the „Filtration“ operating mode

1. When inserting the tubing, always guide the labeled side with your right hand.
2. The pair of tubes are color-coded (red, yellow and green) and are kept in place by two guide plates.
3. The top-to-bottom order follows the traffic light principle: red at the top, yellow in the middle, green at the bottom.
4. The color-coded line of the pair of tubes is always inserted into the front valve slot.
5. After you have inserted the tubing set, check that the result looks like in the picture in Figure 27.

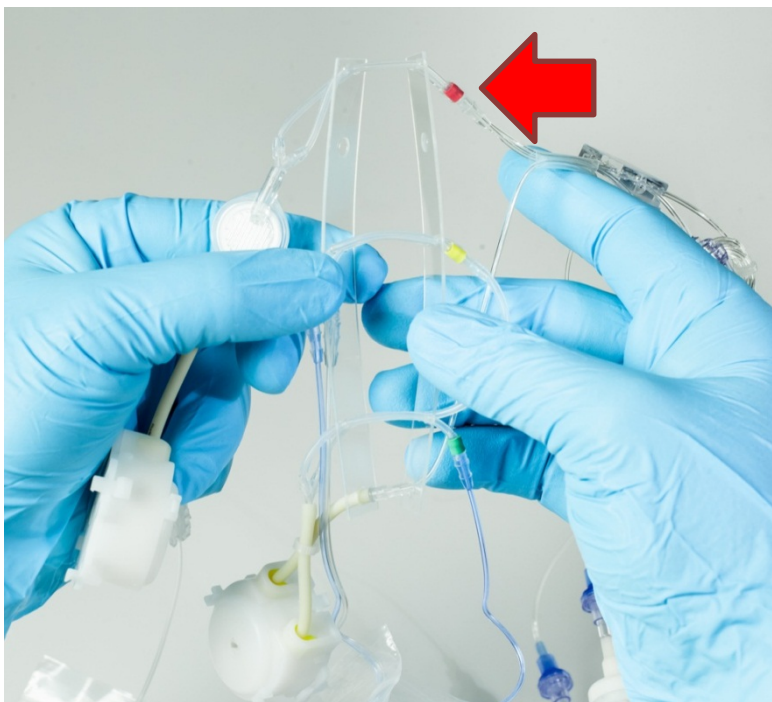

Figure 28: Tightening and aligning of the pair of tubes in the guide plate

As the first step, take both guide plates in both hands and open them slightly in order to align the valve tubes in parallel (Figure 28).

The red pair of tubes must be on top and the label on the right must be visible.





Now place the guide plates on the valves as such that the pair of tubes are positioned on their corresponding valve slots (Figure 29).

When inserting the tubing, make sure that the red, yellow and green color coding is always located to the right of the valve and matches that valve's color coding.

Figure 29: Position of the valve tubes on the device

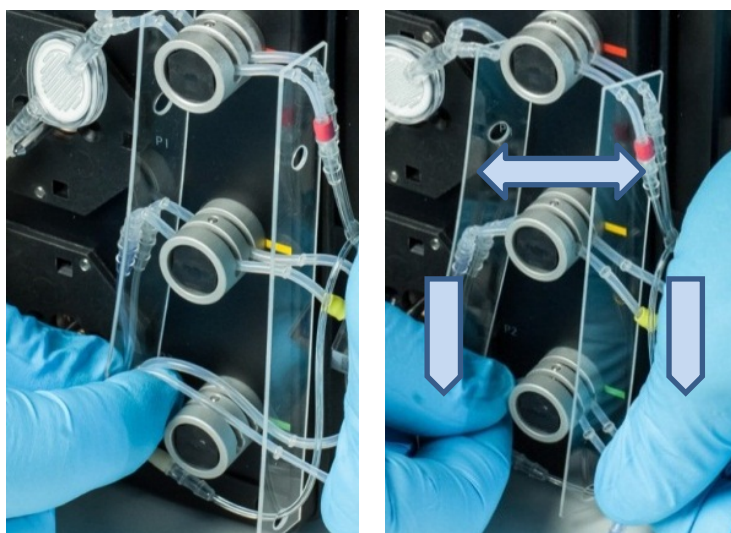

During insertion, hold both sides of the tubing tautly and press the pair down until both tubes are securely seated in their slots (Figure 30).

Figure 30: Tightening and inserting the pair of tubes



Whilst doing so, press alternatively on the black buttons on the valve, to ensure you also insert the rear tubes deep into the valve slot (Figure 31).

Then check that the tubes are fitted correctly in the valve in order to avoid measuring errors.

	<p>Be especially careful that the rear valve tubes were completely inserted into the slots. Only in this way a sufficient function of the valve is guaranteed.</p>
---	--

Figure 31: Manually switching the valve to insert the rear tube securely.





After you are done fitting all three valves, push both guide plates towards the valve in order to secure the position of the tubes in the valve slot (Figure 32).



As the next step, install the two pump cassettes on the motor shaft and press on the retaining plate firmly until you hear an audible click indicating that it has locked in. The proper placement of the pump cassettes must be verified (Figure 33).

Figure 33: Proper placement of the pump cassette (fastening stud locked in place)



Before installing the pump cassettes, check if the motor shaft is clean (if necessary, wipe with a soft cloth). Dirt particles or abrasion of previous applications can adversely affect or even completely prevent the proper functioning of the pump.

The lower pump (P2) and the upper pump (P1) are attached one after the other (Figure 34).



Figure 34: Attaching lower pump cassette P2 and upper pump cassette P1



Figure 35: Fully assembled side panel

After installing the pumps and valves on the front of the device, attach the sensor, drip chamber and diffusion module to the side panel.

Figure 35 shows a completely assembled side panel.



Figure 36: Inserting the measurement cell into the device

First insert the measurement cell into the measurement cell holder (Figure 36). To this end, unscrew the knurled screw on the left retaining plate to allow it to be pushed to the left.

Next, place the right edge of the measurement cell in the recess in the right part of the retaining plate.

Leverage the measurement cell left onto the contact plug. While doing so, pull the left retaining plate slightly to the left.



Figure 37: Fastening the measurement cell to the device

Press the measurement cell onto the holder and slide the retaining plate to the right (Figure 37).

The measurement cell is fastened to the device by tightening the knurled screw.

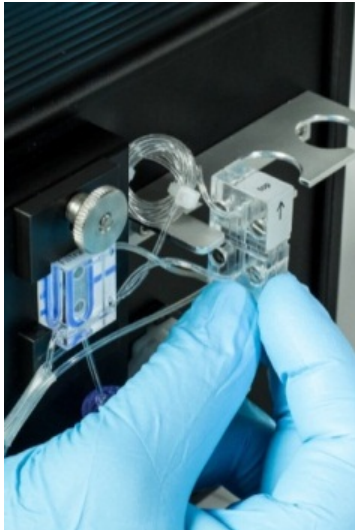

Afterwards, attach the rest of the components to the device. Using the holding slits on the sides, fasten the diffusion module to the mounting rail (Figure 38)

Make sure that the diffusion module is properly aligned with the arrow pointing upwards.

Figure 38: Fastening the diffusion module to the mounting rail



Next, insert the two drip counters into the holder designed for this purpose (Figure 39).

Figure 39: Inserting the drip counters into the holder

### 6.2.5 Attaching the tubing set for the „dialysis“ operating mode

To install the dialysis tubing set, follow the same procedure as for the filtration tubing set.

#### Additional information:

In addition, the dialysis tubing set is provided with a single-use syringe with three-way stopcock for the analysis of external samples. If you want to use this option, you have to place the three-way stopcock between the connection with the green label and the line to calibration standard 1 (see Figure 40).

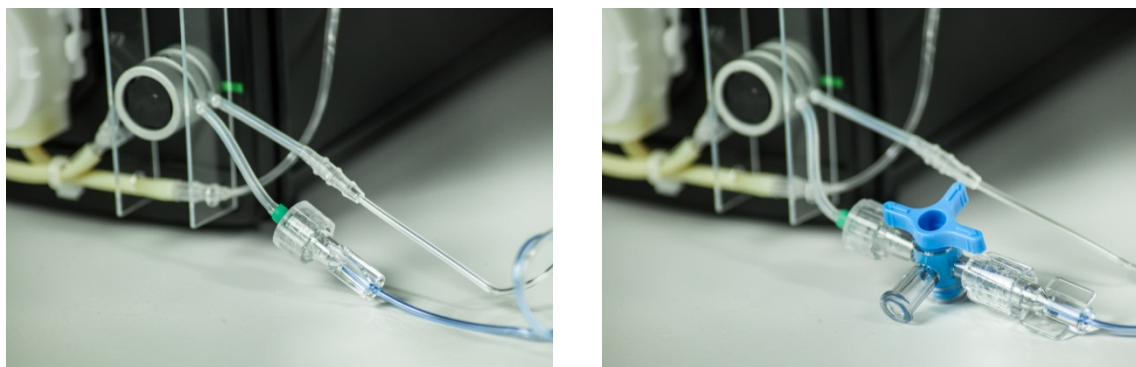

Figure 40: Place of installation for three-way stopcock (left), three-way stopcock + syringe mounted (right)

#### 6.2.5.1 Ancillary equipment M4

The tubing set for M4 applications includes a segment with 4 tubes and 4 additional pump cassettes for the selection of each sampling channel (1-4). See Figure 41 (marked with arrows).

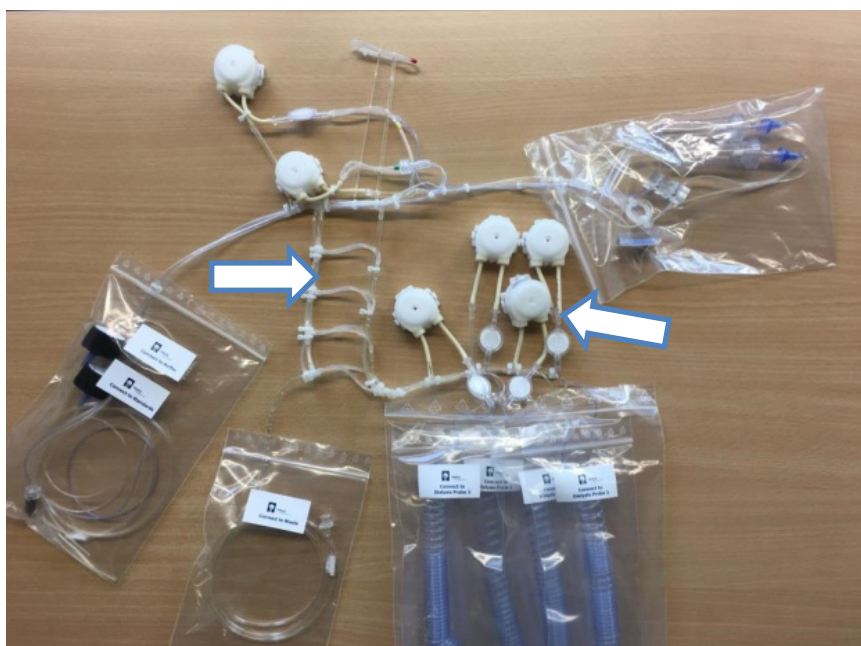

Figure 41: Tubeset M4 - Overview

For a better overview, you first set the tubing set on a table and sort the components as shown in Figure 41.

Leave the bag closed at the partial components so that the assembly is not too confusing.



First, mount the upper part of the tubing set similar to Figure 28 through Figure 39 on pages 51 to 55.

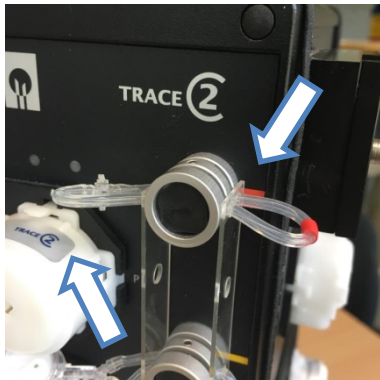

Figure 42: Special features in M4 tubeset

Two main differences are important:

1) the upper, red valve (see arrow) is not used in function (the hose only for attachment).

2) The upper pump P1 is installed transversely for better guidance of the hoses (label points upwards - see arrow).

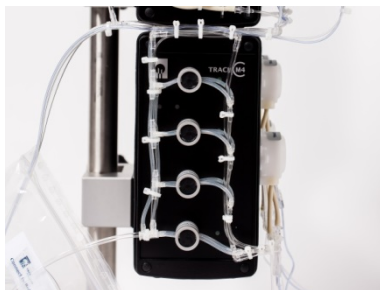

Figure 43: Selection valves M4

Insert the individual valve tubes as shown in Figure 43 and pull the tubes firmly down. Press the black button while introducing the tube deep in the valve slot. Correct fit of the tubes in the valves is then reviewed to avoid errors in the measurement.



Figure 44: Pumps M4

Subsequently, the 4 additional pumps ("Pump 1-4") can be plugged onto the respective motor axes ("P1-4"). See Figure 44.



Figure 45: Critical point (arrow)

Figure 45 shows the finished tubing of the C2 M4. All lines must be checked for correct seating and continuity.

The arrow indicates a critical point where the tubing may twist. As a result, the flow can be prevented, which can lead to a malfunction of the device.

### 6.2.6 Connection and removal of the enzyme reactor

In the "Methanol/Ethanol" operating mode, an enzyme reactor (Figure 46) with immobilized alcohol oxidase is required for the enzymatic conversion of analytes.



Since the enzyme is relatively heat sensitive and cannot be stored dry, the reactor is delivered separately from the tubing set.

The enzyme reactor must be installed into the tubing set intended for this purpose. Due to the storage conditions at 4-8°C, this should only be carried out directly prior to initial operation.

Figure 46: Enzyme reactor

The measurement takes place at room temperature. All solutions (transport buffer, standards) and the enzyme reactor itself must have room temperature.

Prior to installing the reactor, the tubing set must be inserted into the device and filled with buffer. Dry setup may result in decrease of the reactor capacity and shall therefore be absolutely avoided.

First, start the filling process to fill the tubing set. When all lines are flushed with transport buffer, a pop-up message will appear asking to install the enzyme reactor (Figure 47).

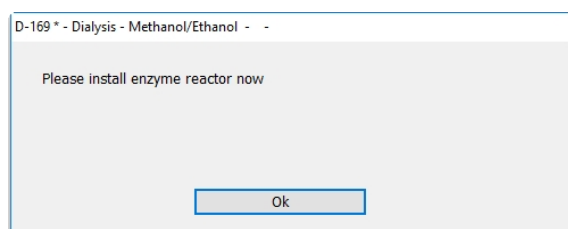



Figure 47: Request for installation of the enzyme reactor

In order to install the enzyme reactor, remove it from the transport container and open the red cover caps. Afterwards, install it into the intended location in the tubing set (see Figure 48).

	If air enters into the enzyme reactor, there is the danger of a decrease in the capacity of the enzyme reactor in association with a lower sensitivity.
---	---

After installing the enzyme reactor proceed as requested by the pop-up message to continue with the filling process with the installed enzyme reactor.

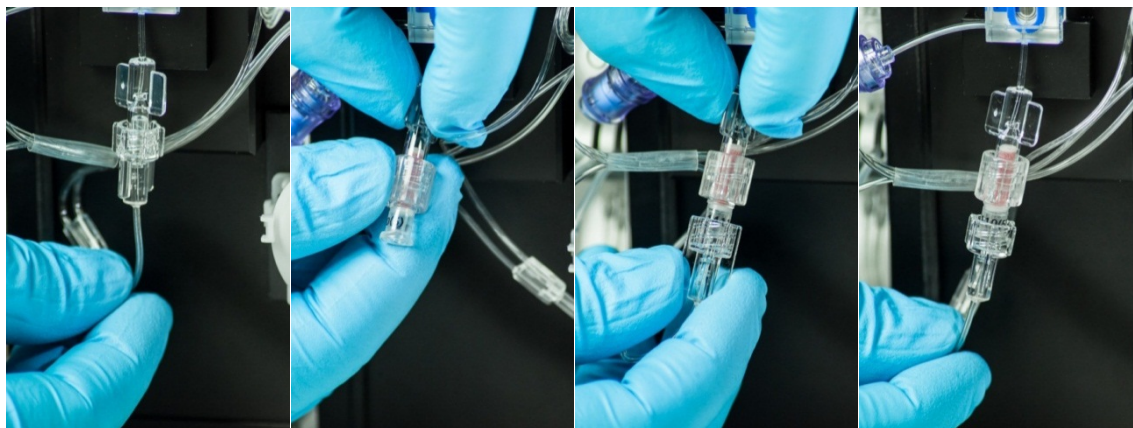

Figure 48: Place of installation and securing the enzyme reactor

The removal of the reactor is also carried out in “stopped” status (“Device – Stop”). The reactor is closed with the red cover caps, placed into the transport container and stored at a cool temperature between 4 – 8 °C.



For further usage, the enzyme reactor must be removed from the tubing set, filled-up with transport buffer and stored in the refrigerator at 4 – 8 °C.

If air enters into the enzyme reactor, there is the danger of a decrease in the capacity of the enzyme reactor resulting in lower sensitivity.

## 6.2.7 Connecting the dialysis probe

### 6.2.7.1 Mounting the dialysis membrane in the dialysis probe

Install a new dialysis membrane before every online measurement involving bioprocesses with sterile feeds as shown in the following Figure 49. If this rule is not observed, a lack of sterility may jeopardize the entire cultivation process.

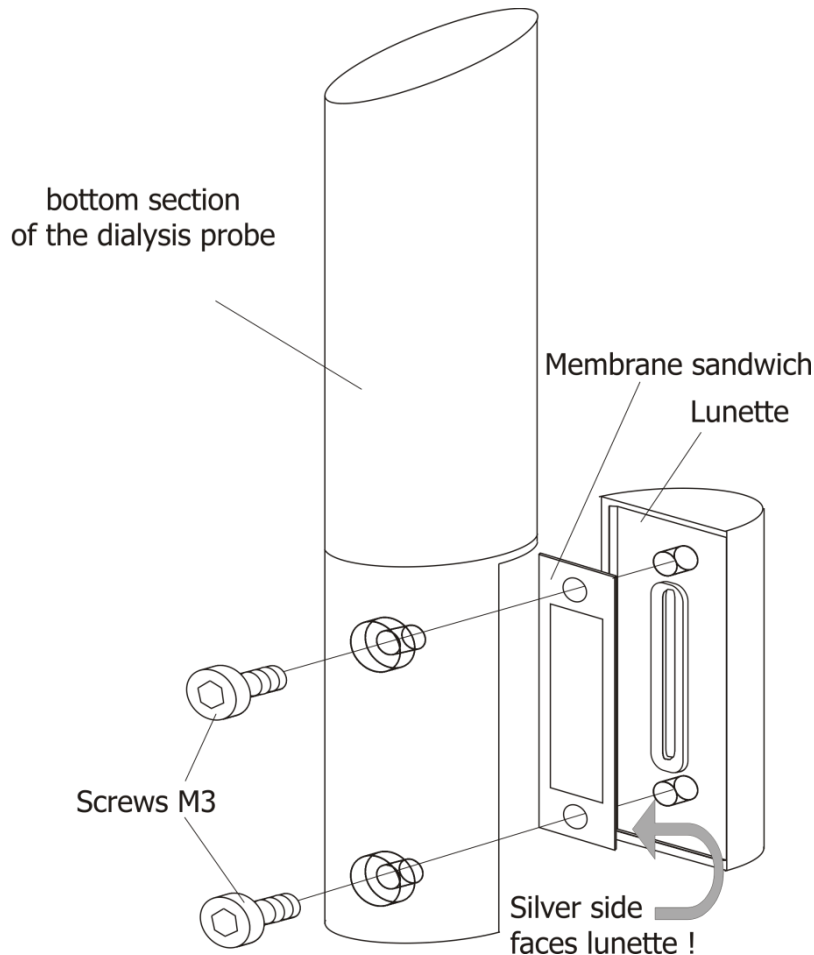



Figure 49: Replacing the membrane in the dialysis probe for the glucose / lactate application

	<p><b>When assembling and operating the dialysis probe, it is imperative that you follow the enclosed instructions.</b></p> <p>It is also extremely important that you follow the procedures described for mounting the membrane for installation into the bioreactor, leak testing, sterilization and cleaning of the probe.</p>
---	---



The new dialysis membrane must be placed correctly (**colored side faces the lunette!**) and the probe lunette must be tightened firmly with the two screws (see following figures).





Figure 50: Inserting a new membrane



Figure 51: Installation of the lunette



Figure 52: Tightening the 2 screws

	<p><b>Incorrect insertion of the membrane may result in leaks in the dialysis probe head and jeopardize the sterility of the entire cultivation process.</b></p> <p>Pay particular attention to ensure that the membrane is seated correctly in the dialysis probe.</p> <p>The white side of the membrane must be inserted facing the dialysis probe (buffer-touching).</p> <p>The colored side of the membrane faces the probe lunette (media-touching).</p>
	 <p><b>For the measurement of methanol and ethanol, a special membrane is required.</b></p> <p>For this purpose a special lunette is to be used with marking "-0.2".</p> <p>Obstructions at the membrane lunette can occur if this special lunette is not used resulting in erroneous readings or leakage in the tubeset.</p>

### 6.2.7.2 Installing the dialysis probe into the bioreactor

Insert the sliding ring and the o-ring prior to the installation in the fermenter (see Figure 53).



Figure 53: Inserting the sliding ring and o-ring

	<p>Attention has to be paid to the minimum immersion depth of the dialysis probe in the bioreactor of 5 cm in order to avoid incorrect measurements.</p> <p>A special membrane is available for smaller bioreactors (&lt;200 ml) with low immersion depth of the dialysis probe (2.5 cm).</p>
---	---

### 6.2.7.3 Installing the dialysis probe into a SU bioreactor

The dialysis probe (length 300 mm) can also be used in single-use bioreactors via a Kleenpak™ Adapter (see Figure 54).

The adapter is available from Thermo Scientific™ - Bioreactor Probe Assembly – Order no. SH3B12122.01.

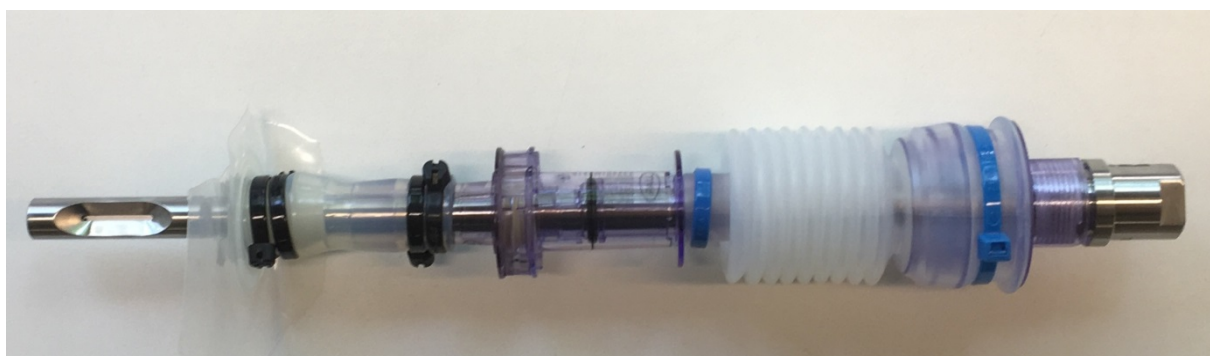

Figure 54: Dialysis probe 300 mm with Kleenpak™ Adapter for use in SU bioreactors

#### 6.2.7.4 Sterilization of the dialysis probe



Before connecting the dialysis probe to the device, the probe must be sterilized along with the bioreactor.

Connect the dialysis probe to the "UNF to LUER" adapter as shown in Figure 55. The inlets and drains on the probe are labeled with arrows on the side. The labels on the tubing set point in the same direction.



Figure 55: Filling the dialysis probe with buffer solution      Figure 56: Sealing the probe prior to sterilization (autoclave loop)

- a) Prior to sterilization, fill the dialysis probe with buffer solution using the single-use syringe and the "UNF to LUER" adapter Figure 55( At the same time, the probe can be checked for any leaks.
- b) For sterilization, seal the probe with the „Autoclave-Loop“(Figure 56). This will prevent one-sided overpressure from occurring at the membrane in the dialysis probe, which could damage the membrane
- c) Now sterilize the reactor
- d) After sterilization: Re-connect the "UNF to LUER" adapter after cooling.
- e) As before, fill the probe with buffer solution by using the single-use syringe and carefully check if it flows freely (Figure 55).
- f) Now the dialysis probe can be connected to the corresponding tubing set of the online analyser.

	<p>Steam sterilization at 1 bar and 121°C. The condition is that the membrane was installed correctly.</p> <p>During sterilization, the probe must be filled with buffer solution and closed with the "Autoclave-Loop" otherwise the membrane may be damaged..</p>
	<p>Dry sterilization is not suitable because the membrane may be damaged.</p>

### 6.2.7.5 Connecting the dialysis probe to the tubing set

The dialysis probe is connected to the online analyser through the dialysis tubing set. The inlets and drains on the probe are labeled with arrows on the side. The labels on the tubing set face the same direction (Figure 57).

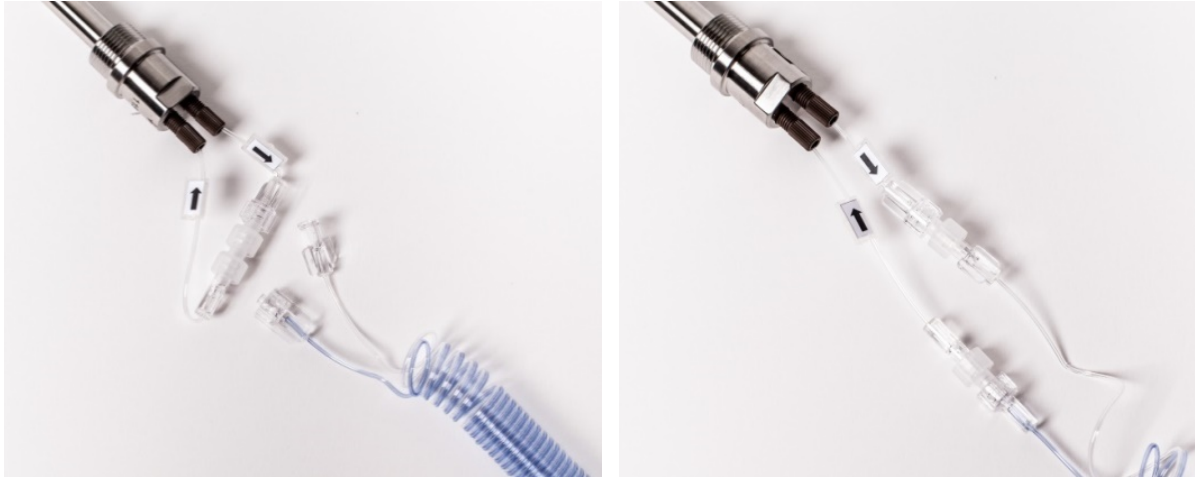

Figure 57: Connecting the dialysis probe to the tubing set

When connecting the probe to the tubing set, care must be taken to ensure that as little air as possible is introduced into the tubing set in the form of small air bubbles, since these could be trapped in the measuring cell which could lead to fluctuating measurements.

#### Procedure:

- First, rinse the probe with buffer or distilled water.
- Then connect only the inlet line (arrow towards the probe) and leave the outlet line (arrow away from the probe) open.
- Then start the measurement. This triggers the probe purge and liquid and any remains of air escape from the output line of the probe.
- The second line of the tubing set is then connected and rinsed for a few minutes.

Basically, air bubbles in the tubing set are rinsed out over time. However, this process takes some time (e.g., during the priming process). If air bubbles are present in the measuring cell after the connection of the dialysis probe, it would be advantageous to operate the system with a maximum measuring frequency for a duration of approx. 30 minutes.



If air bubbles are present in the measuring cell, under no circumstances should calibrations or referencing be carried out, as they may be faulty and consequently lead to incorrect results.

## 6.2.7.6 Cleaning the dialysis probe and replacing the membrane

- a) Before removing the dialysis probe from the bioreactor, the tubing set is removed from the probe by removing the tube ends.
- b) After harvesting the bioreactor or any dead autoclaving phase, remove the dialysis probe from the bioreactor.
- c) The cleaning of the outer surface of the dialysis probe is carried out with a soft brush and water.
- d) Check to make sure that the gaskets on the dialysis probe adapter are clean and seated properly
- e) Remove the two TORX screws on the end of the dialysis probe using the TORX wrench supplied; this allows the dialysis probe lunette to be removed from the lunette holder along with the dialysis membrane.
- f) Afterwards, clean the probe lunette and the lunette holder with a soft brush and water.
- g) Unscrew the UNF Adapter, flush with cleaning solution and distilled water to remove any residual salt.

**Removal of deposits inside the dialysis probe:**

In order to avoid blocking in the dialysis probe which may result in leakages at the tubing set it is necessary to remove deposits inside the dialysis probe.

Rinse the dialysis probe with deionized water using the single-use syringe. Drying afterwards by pressing air through the dialysis probe using the single-use syringe.

### 6.2.8 Connecting the filtration probe

The filtration probe (in-line sampling probe) is intended for harvesting microbe-free filtrate from bioreactors and fermenters under sterile conditions.

A tubular microfiltration membrane made of polypropylene, positioned inside the bioreactor using an in-line probe, serves as a sterile barrier.

The filtration probe is sterilized together with the bioreactor. The sampling probe is installed in the reactor port according to METTLER-TOLEDO® (INGOLD) standard (12 and 19 mm cover port as well as 25 mm side port). The microbe-free filtrate is sampled continuously or discontinuously at the probe head that is accessible outside the bioreactor / fermenter.

For pumping the filtrate, the probe is connected to the filtration tubing set.

Figure 58 below shows the filtration probe for installation in the 12 mm cover port and with shut-off cock for installation in the 25 mm side port.



Figure 58: Filtration probes in 12mm and 25 mm design



**When assembling and operating the filtration probe, it is imperative that you follow the enclosed instructions.**

It is also extremely important that you follow the procedures described for hydrophilizing the polypropylene membrane for installation into the bioreactor, leak testing, in-line sterilization and cleaning of the filtration probe.

### 6.2.8.1 Hydrophilizing the polypropylene membrane

New polypropylene membranes are impermeable for aqueous media (hydrophobic).

Thus, the membrane must be hydrophilized after installation into the filtration probe. Isopropanol (70%, v/v) is used as hydrophilization solution.

The probe is immersed into the hydrophilization solution inside an upright cylinder of sufficient length that the membrane is entirely surrounded by liquid. The alcohol is pumped through the probe into the closed system with a flow rate of 1– 2 ml/min by using a peristaltic pump connected to the sampling outlet of the probe. The hydrophilizing period lasts at least 2 hours. The probe can also be hydrophilized overnight without using the pump by storing it in 70% (v/v) isopropanol.

### 6.2.8.2 Leak test

Once hydrophilization has been completed, a leak test is carried out. In order to do this, the hydrophilization setup described in chapter “6.2.8.3.2 Performing hydrophilization” see Figure 60 is used.

Instead of drawing isopropanol through the membrane of the probe, air is now pumped into the probe. The flow rate should be equal to the flow rate of the previous hydrophilization.

- Many small air bubbles should start to gradually escape from the membrane. Otherwise, the membrane is hydrophilized insufficiently.
- The escape of large air bubbles from the screw connections is an indication for damaged gaskets.

In order to maintain the hydrophilic properties of the membrane until its installation into the bioreactor, it is recommended to store the membrane in a hydrophilization solution (isopropanol 70%). Immediately before installation into the bioreactor, the isopropanol must be replaced with water in order to avoid evaporation and the loss of hydrophilization.

### 6.2.8.3 Using the hydrophilization set

The hydrophilization set is an auxiliary device which assists in setting-up operation of the filtration probe. It can be ordered optionally.

The polypropylene membrane used for the filtration probe is impermeable for aqueous media (hydrophobic). Therefore, the membrane must be hydrophilized with 70% isopropanol solution prior to each use. This hydrophilization can be conducted easily with the hydrophilizing set of the device.



### 6.2.8.3.1 Description of the hydrophilizing set

The hydrophilizing set consists of a pump cassette from which two tubes descend. There is a LUER fitting (for connection to the probe) at one end of the tube. The other end of the tube has no fitting (Figure 59).



Figure 59: Hydrophilizing set with pump cassette and tubing lines

### 6.2.8.3.2 Performing hydrophilization



Figure 60: Setup and connection of the hydrophilizing set

After installing the filtration probe, the polypropylene membrane must be hydrophilized with isopropanol (70%, v/v). The probe is immersed into the 70% isopropanol solution inside an upright cylinder of sufficient length so that the membrane is entirely surrounded by liquid. The tube end with the LUER connector is attached to the filtration probe. The free end of the tube is secured in the upright cylinder so that it hangs freely in the air above the liquid level (see label in Figure 60).

The pump cassette of the hydrophilizing set is attached to a motor shaft of the device. The second motor shaft remains unused.



As shown in Figure 61, the start window appears after starting the “trace\_mon” program in the filtration mode. The operating panel with control buttons for starting (Pump on) and stopping (Pump off) the pump, as well as a control button for the leak test are on the right half of the user interface.

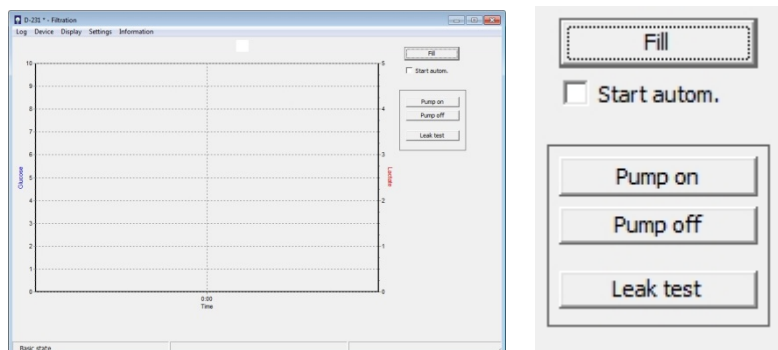

Figure 61: Filtration start window with operating panel to control the pump for hydrophilizing

The hydrophilization process is started by pressing “Pump on”. The isopropanol solution is sucked through the filtration probe and then pumped back into the upright cylinder. The hydrophilizing period should last for at least 2 hours in order to achieve sufficiently high filtration during operation. When the hydrophilization process is complete, the pump is stopped by pressing the “Pump off” button.

#### 6.2.8.3.3 Performing the leak test

Once hydrophilization has been completed, a leak test must be performed via the user interface (Figure 61). To this end, the “Leak test” control button is activated.

The hydrophilization set-up depicted in Figure 60 is used for the leak test. The free tube end of the hydrophilizing set must hang freely in the air above the liquid level in the upright cylinder (see label in Figure 60). The test process takes 8 minutes. Meanwhile, air is pumped into the probe. Afterwards, the pump automatically draws the isopropanol back in through the membrane to ensure that the membrane does not become hydrophobic again.

During the test process, the following should be observable:

- After approx. 6 minutes, many small air bubbles should gradually start to escape from the membrane. Otherwise, the membrane is hydrophilized insufficiently.
- If you observe large air bubbles escaping from the screw connections, this indicates that the gaskets are damaged.

In order to maintain the hydrophilic properties of the membrane until its installation in the bioreactor, it is recommended to store the membrane in 70% isopropanol solution.

Immediately before installation into the bioreactor, the isopropanol must be replaced by water in order to avoid evaporation and the loss of hydrophilization.

To do so, replace the solution in the upright cylinder (Figure 60) with water and start the pump at the operating panel (Figure 61) by pressing the "Pump on" button. Stop the process after approx. 10 minutes by pressing the "Pump off" button. Remove the hydrophilizing set from the filtration probe and install the probe into the bioreactor according to operating instructions.

	<b>Make sure to observe the instructions regarding the filtration probe in the operating instructions.</b>
	Improper assembly, pre-treatment or cleaning of the membrane may cause measurement errors or contaminations of the bioreactor!

#### 6.2.8.4 Connecting the filtration probe to the tubing set

The filtration probe is connected to the device through the filtration tubing set. The male LUER connector of the tubing set can be directly attached to the female LUER connector at the outlet of the filtration probe as shown in Figure 62.

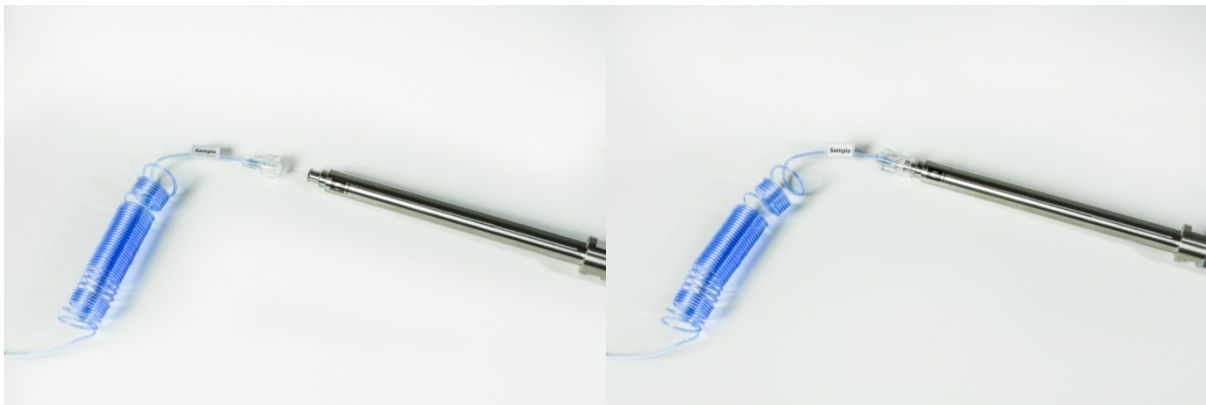

Figure 62: Filtration probe with tubing set / Connection of the filtration probe to the tubing set

#### 6.2.9 Connecting the bypass module

Connecting the bypass module is similar to the dialysis probe (see chapter "6.2.7.5 Connecting the dialysis probe to the tubing set") on page 64.

## 6.3 Loading the software and network connection

The device as well as the ancillary equipment M4 are run internally by a computer and can be operated as a full-ranked member in intranets and LANs, or can be directly interfaced with a PC.

In order to do this, the operating software supplied must be installed on the designated PC. The files needed for the installation of the operating software "trace\_mon" are stored in the device's data memory and can be accessed via an internal device website.

To install the software, proceed as follows:

Connect the device to your network and navigate to the factory-set IP address 192.168.120.231 (for M4: 192.168.120.237) in your web browser.

Here you have the option of downloading important files and the operating instructions onto your computer and of assigning the device an IP address appropriate for your own network.

If you do not want to make any changes (if there is a direct connection with a PC via a cross-over Ethernet cable, for example), then the device will work with the factoryset IP address.

Make sure that your PC is not set to automatic address assignment when using a direct connection (see Figure 63) -static IP mode! (The unit does not operate as DHCP-server!).

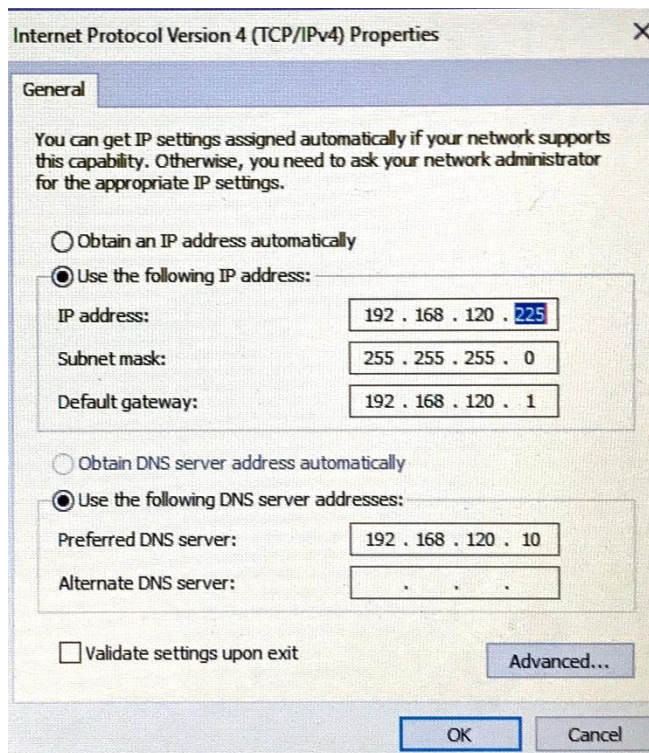

Figure 63: Recommended PC settings for direct connection via crossover Ethernet cable

First download the other important files for the rest of the installation onto your computer by clicking the right mouse button. These can be found in the menu "Download".

The following files can be found here:

- setup\_tracemon\_x\_x\_x as setup file of the operating software (\_x\_x\_x = version number)
- ip\_set as the backup file of the boot file
- Operating instructions for the device as pdf-file
- Excel macro "Macro\_bpd.xlsm"

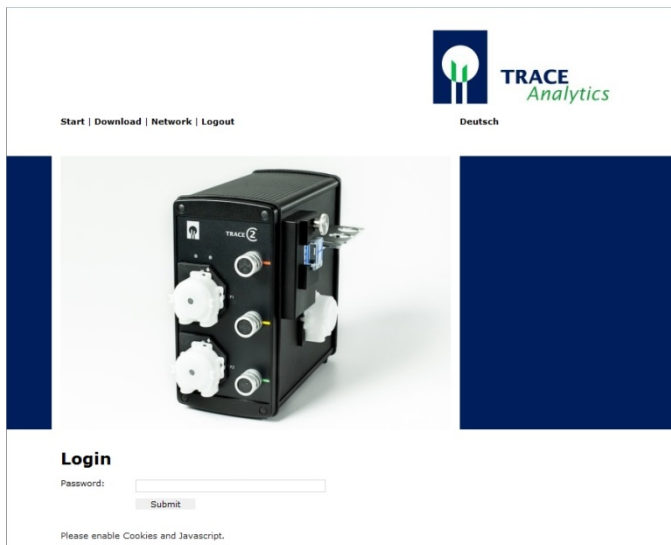

Figure 64: Login for network settings

Then change the device's network address. It can be found in the "Network settings" menu item.

In order to do this, you will need to log in with the password **TuSh1Vf5Ja**.



In most cases, the factory-set IP address will not be compatible with company networks. Have a suitable IP address assigned by your network administrator; otherwise the device may not be able to connect with the operating software.

## Networking

INTERFACE	
address	<input type="text" value="192.168.120.231"/>
netmask	<input type="text" value="255.255.255.0"/>
gateway	<input type="text" value="192.168.120.1"/>

RESOLV.CONF	
search	<input type="text" value="trace-bs.local"/>
nameserver	<input type="text" value="192.168.120.10"/>

Figure 65: Input field for network settings

If you would like to work via a LAN or Intranet that the factory-set network address or the network name may not be compatible with your network. If this is the case, please contact your network administrator and change the device IP address in the form field.

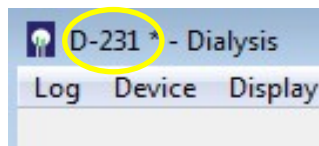

After the network address has been changed, the device can only be accessed via this new IP address. The last 3 characters of the IP address (here 231) represent the number of the device that is displayed in the user interface.

Figure 66: Number of the device

### 6.3.1 Connecting the ancillary equipment M4

The M4 is connected to the network analogously to the TRACE C2. It is factory set with the IP address 192.168.120.237. The connection of the ancillary equipment M4 to the device is described in chapter "7.2.4.3 Basic settings".

### 6.3.2 Troubleshooting

If you have entered different or incorrect IP addresses on the device website and during the installation, it will not be possible to establish a connection. The following options are available:

First, attempt to produce a connection to the internal device website via the standard IP address 192.168.120.231 using a direct PC connection and a cross-over Ethernet cable.

If this is not possible, a change to a known IP address must be forced using the boot file. First switch the device off. Then copy the boot file "ip\_set" onto a USB stick and connect it to the back of the device. Then switch the device on. Once the boot process is complete, the device will now have the new IP address 192.168.120.232.

Navigate to the new IP address 192.168.120.232 in your web browser.  
After the device has been connected in this manner, you can set the network address via your web browser as described above.

## 6.4 Installing the PC-software

Run the file "setup\_tracemon" to install the operating software on your computer. When doing so, you will be asked to enter the new IP address. In order to do this, overwrite the suggested factory-set IP address. If you have not changed the IP address then use "Next" to confirm.

During the installation you will be asked to specify the storage locations for the program and the subsequent measurement data. Next, the software will start the device with the specified IP address and automatically connect to the device.



Make sure that the PC remains permanently active and does not switch to power saving mode.

Otherwise, erroneous readings may result or data may be lost!

## 6.5 Changing the start settings

If you change the IP address at a later point in time, you must also update the start settings in the program link of the "Start" icon to make sure that the device still connects automatically. To do this, complete the following steps:

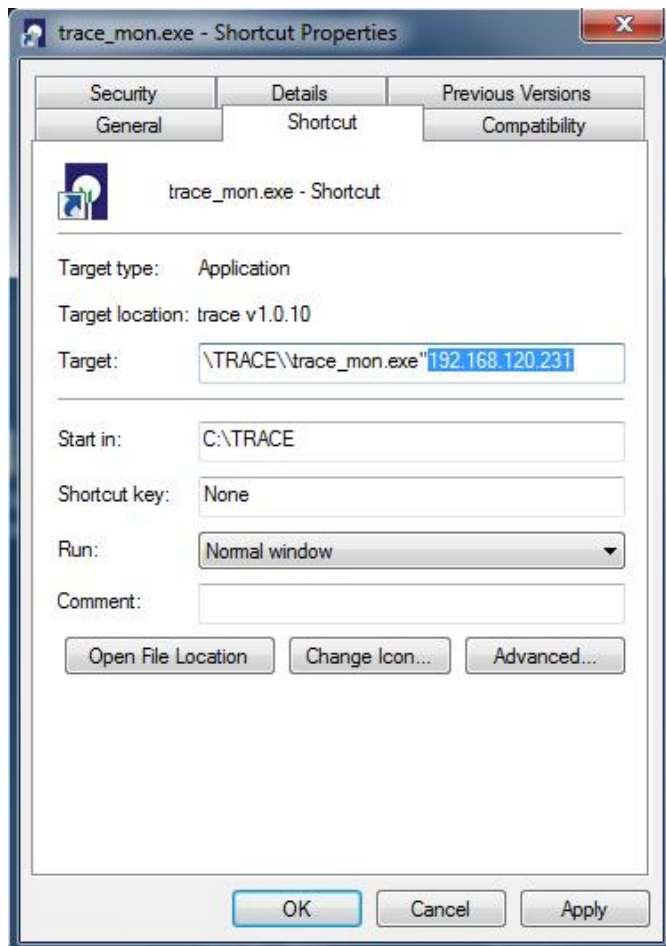

1. Switch the screen view to your desktop.
2. Click on the start icon with the right mouse button.
3. Select the menu item „Properties“
4. Enter "-i" followed by your new IP address at the place indicated in the adjacent Figure 67.
5. Confirm the change with „Apply“ and then „OK“.

Figure 67: Start settings

### 6.5.1 Activate access restriction / Login

To activate the access restriction - by means of which the menu functions are assigned to the various responsible operators - the access privileges can be adjusted using the Login start command "-L".

The device opens then when you first start the administrator mode. The administrator then creates other operators and gives them the access rights (group 0-2). For all subsequent starts initially only the lowest access level (group 0) is active and the respective operator must authorize himself using the menu item "Login" (see chapter "7.2.7 Menu item „Login“")



## 6.6 Assignment of analog outputs

The measured values (and possibly controller outputs) are available for further use as analog signals.

The signal at the analog output is changed whenever there is a new measurement value and remains unchanged unless:

- there is a new measurement value,
- the device is rebooted,
- “New tubing set” is activated.

In the „Parameter“ menu (7.2.4.1 Parameters) the output format can be switched between 0 – 10 V and 2 – 10 V or 0 – 20 mA and 4 – 20 mA.

The output ranges of the analog outputs can be configured as described in chapter „7.2.4.1 Parameters“.

	<p><b>Make sure that no voltage is applied to the analog outputs.</b></p> <p>This can happen, for example, by connecting third-party devices or when using a multimeter in "resistance measurement" mode.</p> <p>Otherwise, damage to the device by destroying the electronic components on the mainboard is possible.</p>
--	--

### 6.6.1 Analog output C2

	Socket	Pin	Signal	Assignment	Glucose / Lactate	Ethanol / Methanol
	Analog 1	pin 1	0-10 V / 2-12 V	Signal Analyte 1	Glucose	Ethanol / Methanol
		pin 2	GND			
		pin 3	0-20 mA / 4-20 mA	Signal Analyte 1		
	Analog 2	pin 1	0-10 V / 2-12 V	Signal Analyte 2	Lactate	-
		pin 2	GND			
		pin 3	0-20 mA / 4-20 mA	Signal Analyte 2		
	Analog 3	pin 1	0 -10 V	Controller output Analyte 1	-	-
		pin 2	GND			
		pin 3		not in use		

Figure 68: Analog outputs at the back side of the C2 device

The measured values remain available for further use as analog signals at the ports analog 1 (Analyte 1 – Glucose) and analog 2 (Analyte 2 – Lactate). When using the ethanol/methanol method, the signal is output on analog 1.

Output Analog 3 can be used for the connection of an external pump which is controlled by an analog signal. The configuration can be defined as described in chapter “7.2.6 Menu item „Controller“”.

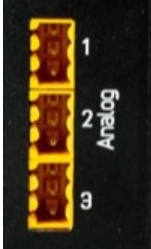

## 6.6.2 Analog output C2/M4

If the combination of C2 with the auxiliary device M4 is used, additional analog ports are available. In this case the signals of analyte 1 (glucose, or ethanol / methanol) and analyte 2 (lactate) are output via the following analog outputs:

	Socket	Pin	Signal	Assignment	Glucose / Lactate	Ethanol / Methanol
C2 Control	Analog 1	pin 1	0-10 V / 2-12 V	Signal Test Port 1	Glucose	Ethanol / Methanol
		pin 2	GND			
		pin 3	0-20 mA / 4-20 mA	Signal Test Port 1		
	Analog 2	pin 1	0-10 V / 2-12 V	Signal Test Port 2	Glucose	Ethanol / Methanol
		pin 2	GND			
		pin 3	0-20 mA / 4-20 mA	Signal Test Port 2		
	Analog 3	pin 1	0-10 V	Signal Test Port 4	Glucose	Ethanol / Methanol
		pin 2	GND			
		pin 3	0-10 V	Signal Test Port 3		
M4	Analog 1	pin 1	0-10 V / 2-12 V	Signal Test Port 1	Lactate	-
		pin 2	GND			
		pin 3	0-20 mA / 4-20 mA	Signal Test Port 1		
	Analog 2	pin 1	0-10 V / 2-12 V	Signal Test Port 2	Lactate	-
		pin 2	GND			
		pin 3	0-20 mA / 4-20 mA	Signal Test Port 2		
	Analog 3	pin 1	0-10 V	Signal Test Port 4	Lactate	-
		pin 2	GND			
		pin 3	0-10 V	Signal Test Port 3		

Figure 69: Assignment of analog outputs on the C2/M4

## 6.7 Device Startup

Before every startup, check the device to make sure that all modules installed on the device are functional. The following conditions must be checked scrupulously on the device:

- Are the two original pump cassettes installed properly?
- Is the tubing set connected completely and properly?
- Is the enzyme reactor installed in the methanol / ethanol operating mode?
- Is there a measurement cell in the holder?
- Are the available volumes of transport buffer and the appropriate calibration solutions ready at hand?

If these checks are passed, you can start the device. Chapter "7 Operation" describes in detail the operating software functions necessary to start the device. In principle, the following procedure must be maintained:

- 1) In the "Basic settings" menu, select the measurement method / application (chapter "7.2.4.3 Basic settings").
- 2) In the "Parameter" menu, configure the calibration standards and measuring and calibration frequency you want to use (chapter "7.2.4.1 Parameters").
- 3) After you have connected all tubing and sampling lines, start the filling routine (chapter "7 Operation").
- 4) After priming, the device starts with the measurements automatically (if the autostart option was activated) or switches to the "Standby" mode.

If you are working with the dialysis method, you must carry out a reference measurement at the right time in order to obtain conclusive results. Proceed as described in chapter "7 Operation".

## 6.8 Decommissioning

The device can be switched off at any time by pressing the power switch. The calibration and reference values last stored remain in memory for the next start (see section "7.2.2.1 Connect").

If the measuring instrument is not operated for two days (e.g. over the weekend), the buffer-filled system may remain standing. In the event that the device will be out of use for longer periods of time, the tubing set must be replaced before re-starting operations.

For decommissioning in the methanol / ethanol operating mode, the enzyme reactor must be removed and stored at a cool temperature (see chapter "6.2.6 Connection and removal of the enzyme reactor").

## 7 Operation

Switch on the device at the power switch located on the back panel and run it on an external PC.

	<p>Make sure that the PC remains permanently active and does not switch to power saving mode.</p> <p>Otherwise, erroneous readings may result or data may be lost!</p>
---	--

You will find the trace\_mon start icon on the PC's desktop . Double-clicking it will start the application. The user interface shown in Figure 70 appears.

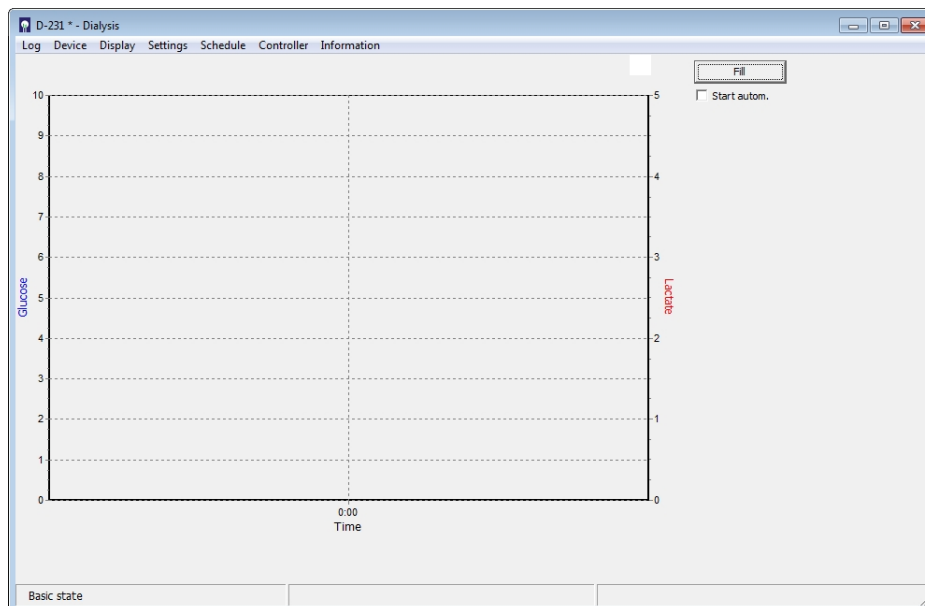

Figure 70: Start window indicating the selection and display ranges

The device number appears in the header. In this case, it's „231\*“. The asterisk indicates that a connection exists between the control PC and the device. If there is no connection to the measuring instrument, it must be established (see section “6.3 Loading the software and network connection”).

The measurement display can be modified at any time during operation. Press the right mouse button to display the input field for configuring the view.

Here, you can configure dot sizes, dot colors and the axis scales (Figure 71).

The default settings are the color blue for glucose and red for lactate. A green dot color is preset for methanol or ethanol.

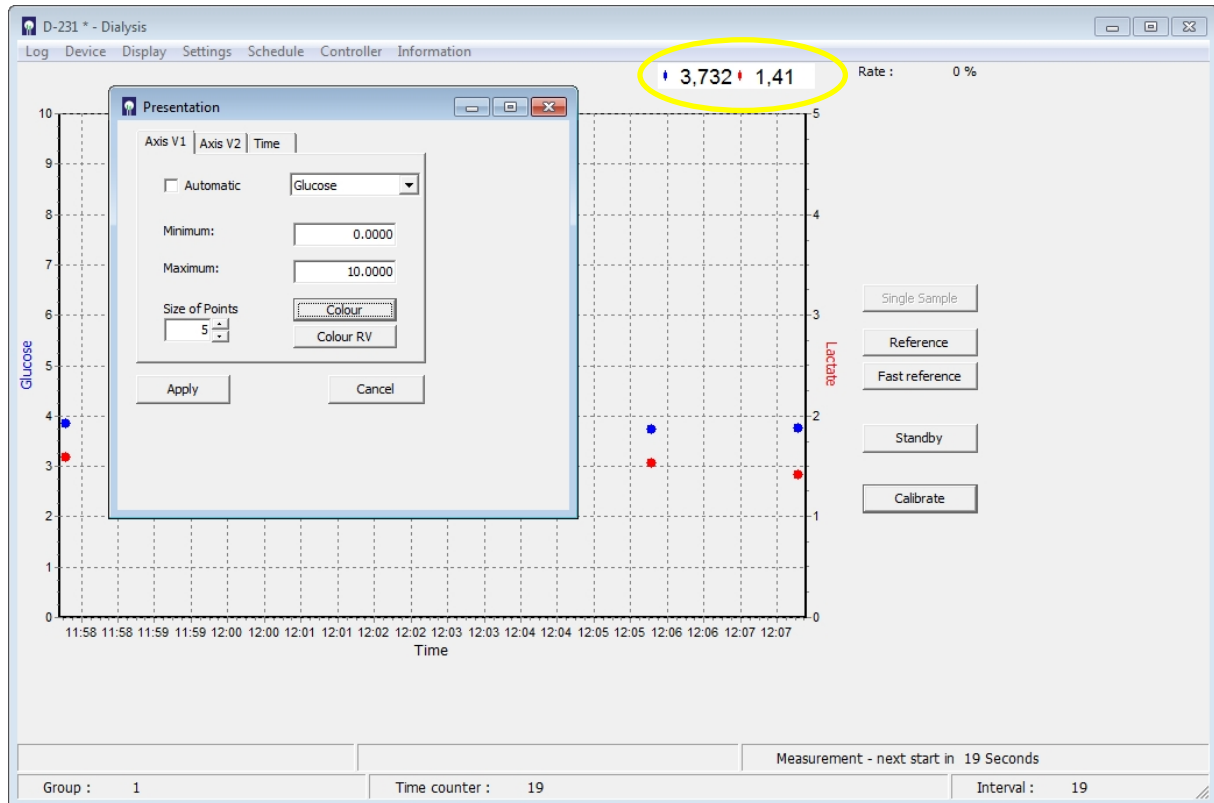

Figure 71: Screen shot for adjusting the measured values display

Actual measurement results are presented in the data display in (see Figure 71) circled in yellow).

The following additional actions can be selected:

Moving the graph:

- Hold down the right mouse button and move

Zoom:

- Pull the window from the upper right down to the lower left (hold down left mouse button).

Return to start screen:

- Pull the window from the lower left up to the upper right (hold down left mouse button).

The following menu items can be selected from the task bar: Log, Device, Display, Settings, Schedule, Controller, Login and Information.

The device status is displayed under the graphic display. At the beginning, the device is in default mode. To the right of the graphic display there is an area for context-based selection buttons. A panel will occur when the priming process is finished.

Every time the device restarts, completely fill the tubing set and run several preliminary measurements to render the sensor system stable before initiating the calibration routine. This process is called priming; alongside filling and preliminary measurements, it also includes an initial calibration of the system.

After priming, the device switches to "Standby" mode. Depending on the measuring method selected, the entire process takes between 40 and 60 minutes.

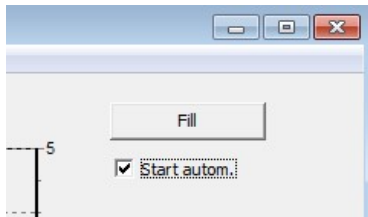



Figure 72: Autostart

Another option is to configure the device to start with the measurements immediately after the priming routine. If a check mark is placed next to "Start automatically" (Figure 72, the device will automatically initiate the measurement after performing the initial calibration routine.

If the "Fill" button is pressed, the device starts filling and the "Fill" button disappears.

	<p>Before you start up your system with autostart, make sure that the tubing set is properly connected to the sampling outlet on the bioreactor.</p>
---	--

When the system is ready to run the measurement, the status message "Standby" in the lower right will appear. When the priming is completed, a panel for context based selection buttons is available (Figure 73).

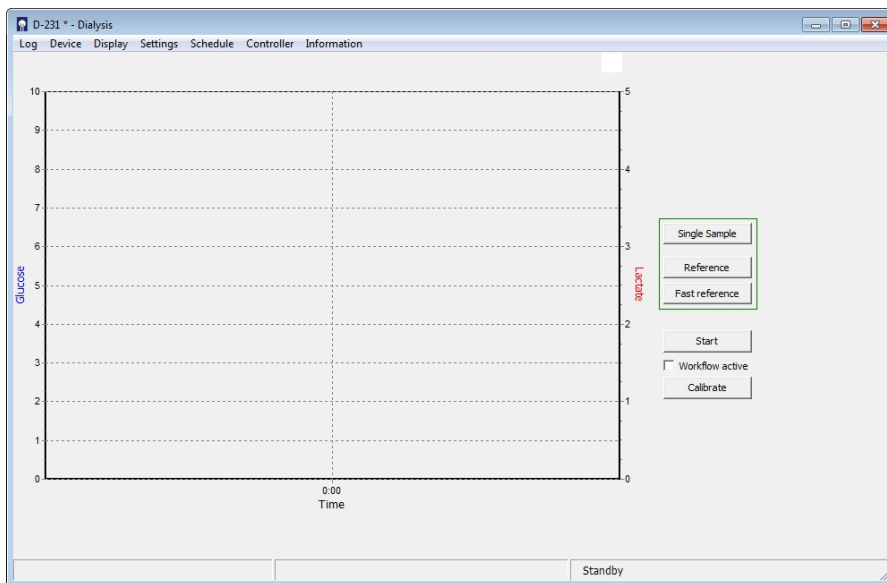
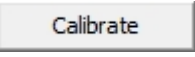
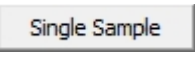

Figure 73: Screen display in "Standby mode"

The button  starts the measurement.

The button  stops measuring, calibration etc.

The button  activates a calibration measurement.

The button  activates only one measurement at the chosen channel.

In the dialysis mode further buttons appear labeled 

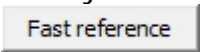
and .

## 7.1 Basic Commands

### 7.1.1 Start

The "Start" command starts the measurements of the analyser. The command can either be triggered directly by pressing the "Start" button or by a corresponding entry in the schedule (chapter "7.2.5.1.1 Events"). In this case, the command will only be executed when the specified time is reached.

### 7.1.2 Standby

The command "Standby" stops the current action of the device. The command can either be triggered directly by pressing the "Standby" button or by a corresponding entry in the schedule (chapter "7.2.5.1.1 Events"). In this case, the command will only be executed when the specified time is reached.

### 7.1.3 Calibrate

The command „Calibrate“ triggers a calibration. There are different options to start a calibration:

- By clicking on the button "calibrate"
- Autocalibration (based on a number of measurements performed in between, see Chapter "7.2.4.1 Parameters")
- By a corresponding entry in the event list (Chapter „7.2.5.1.1 Events“). In this case the command will be proceeded when the respective time is reached.
- By a corresponding entry in the workflow (chapter "7.2.5.1.2 Workflow").

### 7.1.4 Single Sample

This function can be used for a spontaneous unscheduled single point measurement at a selected port (M4). This function is especially useful during long intervals, when for instance an actual value of a certain reactor is wanted. By this option, the running program does not need to be interrupted and the planned intervals remain unchanged.

The "single sample" command is only triggered, if there is enough available time for the measurement.

### 7.1.5 Reference (for dialysis only)

A reference measurement must be performed to compare the permeability of the two diffusion membranes in the diffusion cell (that is only allowed contact with calibration solutions) and in the dialysis probe (that only has contact with the reactor contents). The relationship of the two membranes to one another is expressed by a reference factor that is used for calculating the measured values.

You can conduct a reference measurement whenever you want, in particular when changes occur in the process that may influence the diffusion speed (e.g. as a result of temperature changes).

Reference measurements can also be carried out at regular intervals, e.g. when samples are taken for external accompanying analysis. The measured value is only

corrected with a new reference factor when the new reference value was entered and confirmed by pressing “Apply”. Up to then, measured values that were determined in the meantime are always calculated and displayed with the current reference factor.

The device starts with a reference factor of 1.0. If the two membranes were permeable to the same degree, then this value would be correct. In practice, however, experience has shown that manufacturing-related and ambient conditions affecting the probe can result in differences.

The comparison is activated as follows: After clicking the “Reference” button, the device determines the concentration in the reactor and suggests the corresponding values (see Figure 74). Now, using a reference sample, you must check whether these values are correct and adjust them accordingly. If you already know the concentration values (e.g. from the initial weight), you can enter these values directly. Alternatively, you can determine the concentrations in the reactor with an external sample using an offline analyser.

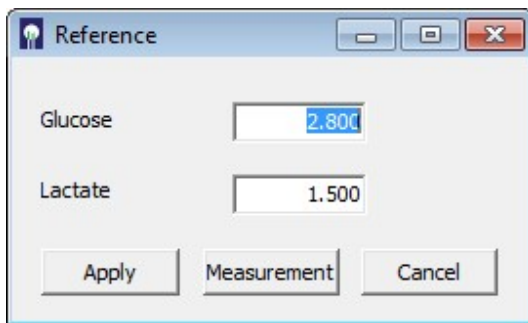

Figure 74: Display after reference measurement

Confirm the prompted measured values with “Accept”. If you want to make changes, enter the new values into the entry field and confirm with “Accept”. With the “Discard” function, you can cancel the procedure and move back to the starting position.

As long as the input window is open and no new reference values were entered and confirmed, the device continues working with the current reference factor.

If determining a reference measurement using an external analyser is going to take longer and the medium concentration is expected to change in the meantime, you should wait for the reference measurement and only then take a sample for external analysis. When the input window for the reference values appears, the device has stored the currently measured concentration to compare it with subsequently entered values and determine the new reference factor.

If no offline analyser is available for determining reference values, you can also measure the sample on the device. To do so, select the “Measurement” function and follow the further instructions prompted by the menu navigation (see Figure 75).



Figure 75: Prompt for sampling and connection to the three-way stopcock

Draw a cell-free sample from the bioreactor (at least 5 mL) into a 5 mL syringe and connect it to the three-way stopcock as shown in Figure 76. Check that the three-way stopcock is in the correct position: The arrows on the stopcock must point towards the green tube marking and the syringe.



Figure 76: Connecting the external sample





Only use the "Sample ready" function if you are sure that the filled syringe is connected and the three-way stopcock is set to the proper position. Otherwise erroneous measurements may result!

"Sample ready" is activated to measure the external sample. Three measurements are taken and their average displayed as a result. As described above, you can then accept, correct or discard measured values or you can perform another measurement on an external sample.

Before you continue working, make sure that the three-way valve was set back to the initial position (see Figure 77), so that you can correctly measure Standard 1 during the next calibration.



Figure 77: Correct position of the three-way stopcock



Make sure that the three-way stopcock is set as displayed. Otherwise all following calibrations will be erroneous and the resulting measurements incorrect!

### 7.1.6 Fast Reference (only for dialysis)

In use of the dialysis method it is necessary to perform a referencing in order to match the permeability of the membranes within the reactor and outside in the diffusion cell, and to compensate for temperature differences between the two membranes. A reliable determination of the reference factor is therefore very important for the quality of the measurement results.

Normally, a measurement is triggered by the "reference" option and the measurement result is communicated. The user can then confirm the measured values (reference factor does not change), correct the value or perform the analysis of an external sample. For processes with slow concentration changes (e.g. cell cultures) and already known concentration values in the medium, this procedure can be accelerated by using the "Fast Reference".

The "Fast Reference" option allows a faster implementation of the reference measurement, in which the known concentration values of the medium can be entered before the actual reference measurement.

After pressing the "Fast Reference" button, the input window appears (Figure 78).

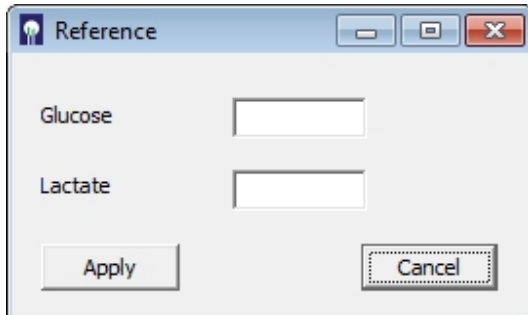

Figure 78: Display after fast reference

Now enter the corresponding concentration values and confirm with "Apply". The device will then begin with the reference measurement and when finished automatically returns to the state it was in when the "Fast Reference" button was triggered. "Cancel" will cancel the operation and return to the starting position.

As long as the input window is open and no new reference values have been registered and confirmed, the device still works with the current reference factor.

In case of several connected probes (via the M4), the fast reference can be carried out automatically for selected ports.

To do this, the menu item "Autoreference" is used in the main menu bar "Scheduler". For detailed information see chapter "7.2.5.2 Autoreference (Dialysis mode only)" on page 104.

## 7.2 Menu bar

### 7.2.1 Menu item „Log“

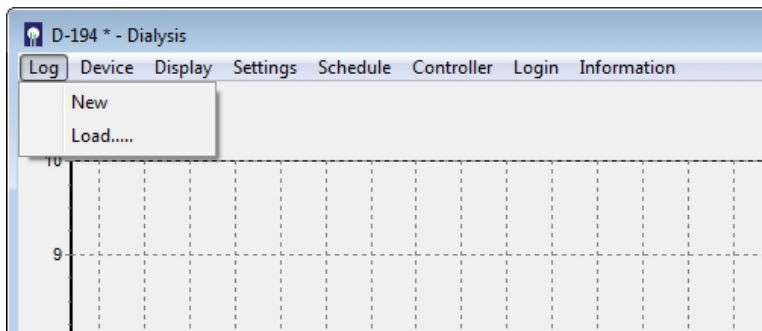

Figure 79: Menu option „Log“

The measured data are displayed in the trace\_mon diagram and additionally recorded as text in a bpd-file. This file is saved in the default subdirectory „Data“.

If the network connection between the device and the PC is interrupted, the data in the device will be buffered until a connection is restored. The missing data is then automatically transferred to the trace\_mon software.

In addition to the date and time the respective data for temperature at the measurement cell, glucose reading and lactate reading will be logged. If the controller is active, the respective feed rate (1 = 100%) is recorded. If the device is in the M4 mode, the port for which the values apply is logged as well.

If you want to create a new file, select the menu item „New“.

If you want to load and display measured data from an old file, select the menu item „Load...“.

The saved bpd-files can be easily processed, e.g. in Excel. For notes on importing as an Excel file see chapter „8.6 Import data to Excel“.

## 7.2.2 Menu item „Device“

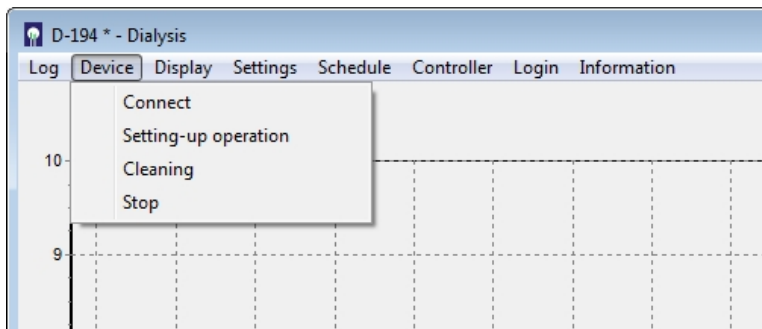



Figure 80: Menu option „Device“

The user can choose from four sub-items:

“Connect”, “Setting-up operation”, “Cleaning” and “Stop” (see Figure 80).

### 7.2.2.1 Connect

By selecting the “Connect” menu item, you have the option to connect a new Device. To do so, you must enter the IP address of the device (Figure 81).

If you have started the software by clicking on the start icon  on the desktop, the standard IP address 192.168.120.231 will already be displayed.

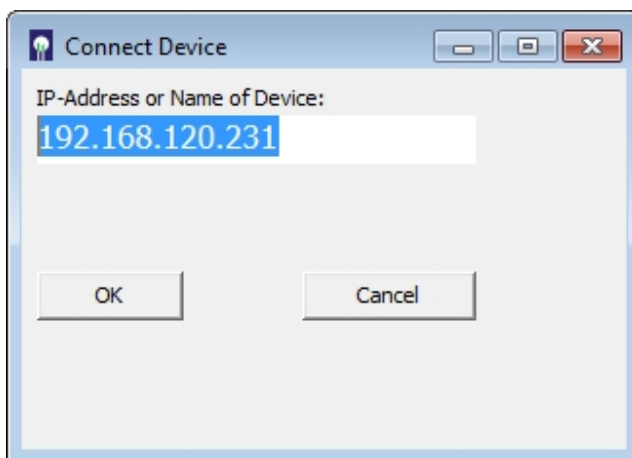
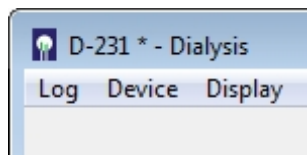

Figure 81: Connect device

If your device has been assigned a different IP address (e.g. by your network administrator), then enter that address here.

If you would also like to be prompted with this new address automatically in the future, proceed as described in section “6.5 Changing the start settings”.



Once you have entered the correct IP address and the device is acknowledged by the network, it will connect to the control PC. An asterisk appears in the view bar behind the name or number of the device.

#### 7.2.2.2 Setting-up operation

If the tubing set has been replaced, you must go to the menu item “Setting-up operation”. “Setting-up operation” deactivates all previous calibration and reference data and requires that the tubing system is re-primed.

#### 7.2.2.3 Cleaning

For longer waiting times the cleaning mode must be used. For this purpose, all of the lines of standards and transport buffer, and optionally the filtration line have to be connected to the cleaning solution (Order No. 850.300.710/850.300.711). Then in the menu “Device” the option “Cleaning” is selected.

This option starts an automatic cleaning procedure. Here, a procedure is carried out, in which all the lines are flushed at certain intervals. When the cleaning solution has been used up repeat with distilled water in order to remove all residual salt that may clog the tubing during storage.

See chapter “10.2 Tubing set cleaning” for further details.

To recommissioning of the tubing set the tubes need to be properly inserted again. Then, a priming procedure with transport buffer is necessary.

### 7.2.2.4 Stop

“Stop” is used for temporary decommissioning of the system, e.g. when the monitored bioprocess is interrupted, for short operating interruptions or when connecting enzyme reactors (see chapter “6.2.6 Connection and removal of the enzyme reactor”). Select the menu item “Stop” to interrupt the measuring routine and ready status. All pumps stop and the valves shut. In this event, the device will retain stored data on calibration and reference values.

Click the „Stop“ button and the device switches to standby. The program can now be closed. The device can also be switched off at the power switch without losing any data. When switching the device back on or re-booting the control program, the prompt screen shown in Figure 82 appears.

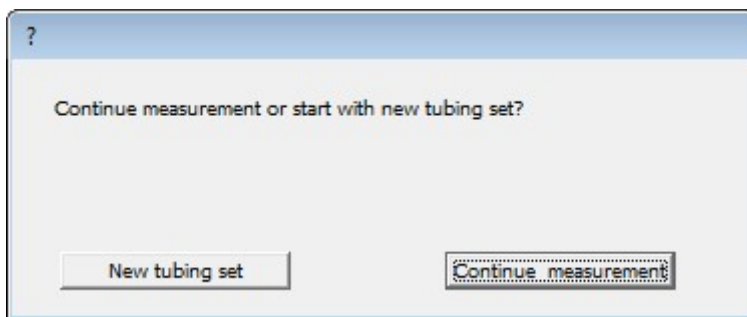



Figure 82: Restart prompt window after „Stop“

By clicking on the button “Continue measurement”, the system switches directly to operational mode. No rinsing cycles or calibrations will be carried out. The former calibration values will be retained.

	Do not activate “Continue measurement” unless you are certain that the same conditions prevail as before the pause (e.g. in the event of brief interruptions). Otherwise, this may result in erroneous measurements!
---	--

In the case of longer interruptions (e.g. overnight), it is recommended to carry out a calibration before continuing with further measurements.

### 7.2.3 Menu item „Display“

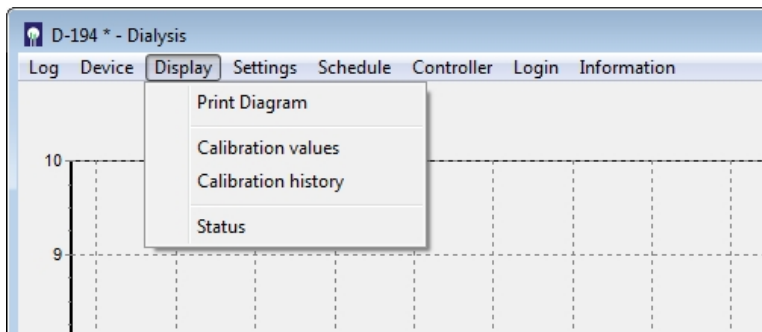

Figure 83: Menu option “Display“

#### 7.2.3.1 Print Diagram

By selecting the menu item “Print diagram”, the currently displayed diagram is printed out on an interfaced printer.

#### 7.2.3.2 Calibration values

When the menu item “Calibration values” is selected, a window opens that shows the current calibration values (Figure 84).

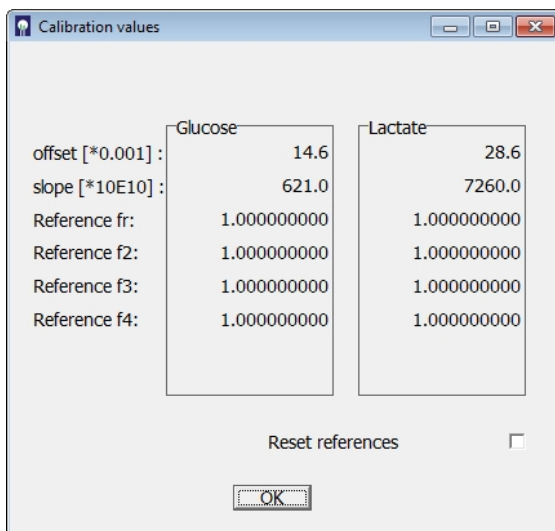

Figure 84: Screen shot of current calibration values

The axis intercepts ( $a_0$ ), calibration gradient ( $a_1$ ) and the reference factors (Reference fr – fr4) are displayed.

Activating the option “Reset reference” resets the reference factors to the factor 1.0 (only in dialysis mode).



### 7.2.3.3 Calibration history

When the menu item “Calibration history” is selected, a window opens that shows the current calibration history (Figure 85).

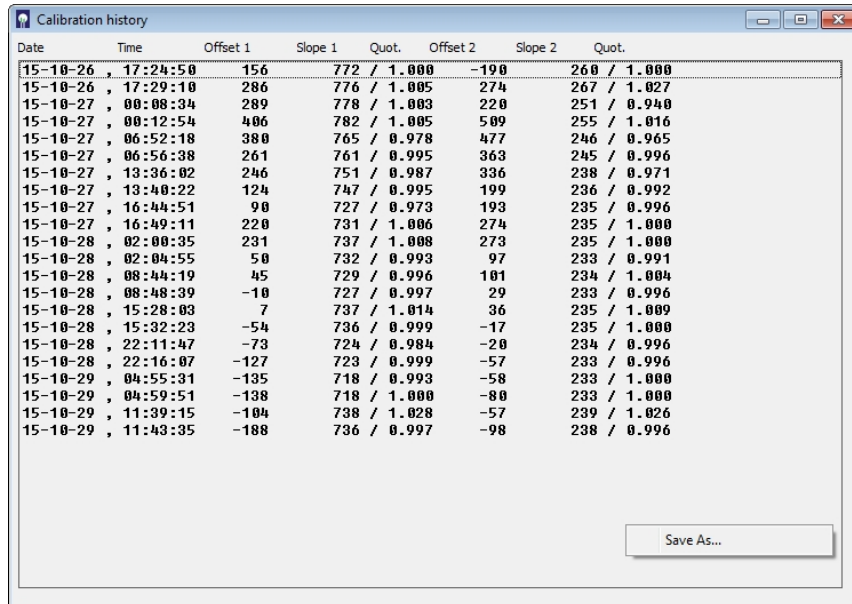

Date	Time	Offset 1	Slope 1	Quot.	Offset 2	Slope 2	Quot.
15-10-26	17:24:50	156	772 / 1.000	-190	260 / 1.000		
15-10-26	17:29:10	286	776 / 1.005	274	267 / 1.027		
15-10-27	00:08:34	289	778 / 1.003	220	251 / 0.940		
15-10-27	00:12:54	406	782 / 1.005	509	255 / 1.016		
15-10-27	06:52:18	380	765 / 0.978	477	246 / 0.965		
15-10-27	06:56:38	261	761 / 0.995	363	245 / 0.996		
15-10-27	13:36:02	246	751 / 0.987	336	238 / 0.971		
15-10-27	13:40:22	124	747 / 0.995	199	236 / 0.992		
15-10-27	16:44:51	90	727 / 0.973	193	235 / 0.996		
15-10-27	16:49:11	220	731 / 1.006	274	235 / 1.000		
15-10-28	02:00:35	231	737 / 1.008	273	235 / 1.000		
15-10-28	02:04:55	50	732 / 0.993	97	233 / 0.991		
15-10-28	08:44:19	45	729 / 0.996	101	234 / 1.004		
15-10-28	08:48:39	-10	727 / 0.997	29	233 / 0.996		
15-10-28	15:28:03	7	737 / 1.014	36	235 / 1.009		
15-10-28	15:32:23	-54	736 / 0.999	-17	235 / 1.000		
15-10-28	22:11:47	-73	724 / 0.984	-20	234 / 0.996		
15-10-28	22:16:07	-127	723 / 0.999	-57	233 / 0.996		
15-10-29	04:55:31	-135	718 / 0.993	-58	233 / 1.000		
15-10-29	04:59:51	-138	718 / 1.000	-80	233 / 1.000		
15-10-29	11:39:15	-104	738 / 1.028	-57	239 / 1.026		
15-10-29	11:43:35	-188	736 / 0.997	-98	238 / 0.996		

Figure 85: Screen shot of current calibration history

By clicking the right mouse button, the calibration history can be saved as txt.-file.

### 7.2.3.4 Status

When the menu item “Status” is selected, an information bar appears at the bottom edge of the screen that displays further information on the current status in three fields (see Figure 86). This function is of particular interest for long intervals or group measurements.

The number of pending group measurements (or preliminary measurements) is displayed in field 1. In field 2, a current time count counts down the time until the end of the current action (in seconds). The remaining time in the interval of the measurement period is displayed in field 3 (in seconds).

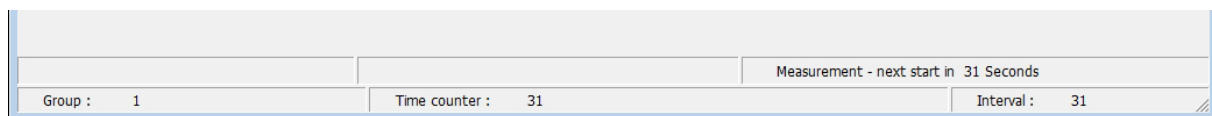

Measurement - next start in 31 Seconds		
Group : 1	Time counter : 31	Interval : 31

Figure 86: Screen display of status bar

## 7.2.4 Menu item „Settings“

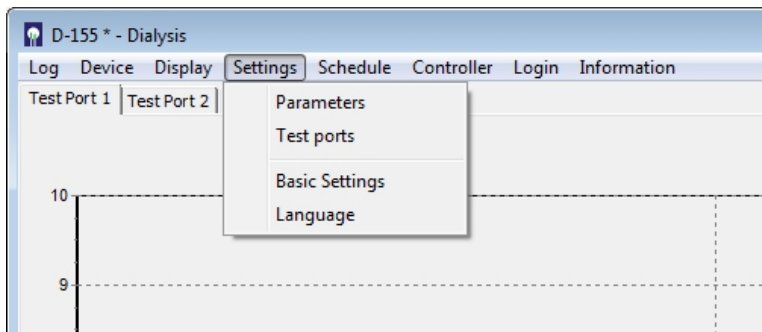

Figure 87: Menu option "Settings"

In the "Settings" menu options, you can configure the most important device settings for operation and communication:

### Parameters

- Allow the user-specific configuration of measurement frequency, calibration frequency, concentration of the calibration standards, data transfer etc.

### Test ports (ancillary equipment M4)

- Here, up to four test ports are activated. This is the case when using the M4 and individual reactors have not yet been put into operation or should not be used. At least one test port must remain activated.

### Basic settings

- Here you can configure the device for the selected sampling method. Likewise, the user can enter information about the device and the project that later appear on the data output.
- In addition, the possible peripheral devices (test port extension M4 or controller feed pumps P4) are defined in this menu.

### Language

- Here you can change the menu guidance language.

### 7.2.4.1 Parameters

All relevant parameters for measuring operations can be configured in the “Parameters” sub-item (Figure 88).

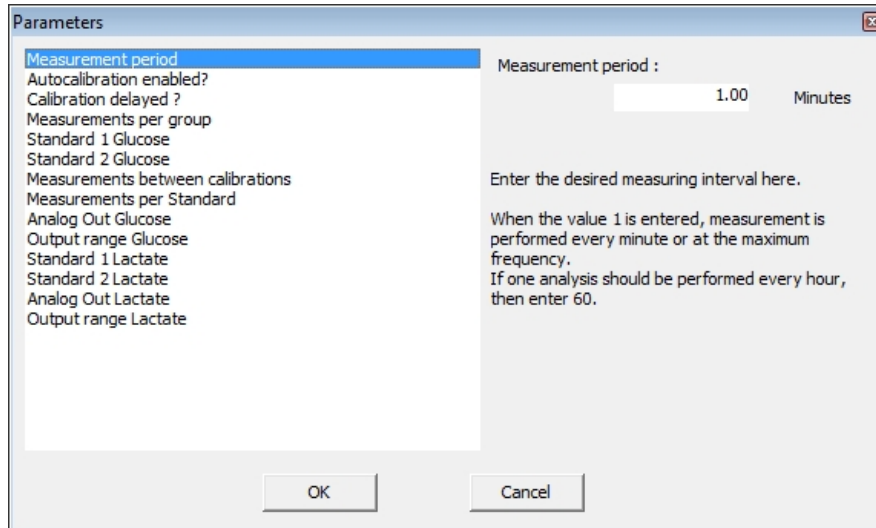

Figure 88: Entry screen for configuring the measurement parameters

#### Measurement period

- Enter the desired measuring interval here. When the value 1 is entered, measurement is performed every minute or at the maximum frequency. If one analysis should be performed every hour, then enter 60.
- The frequency can be changed at any time and becomes immediately effective by clicking „Ok“.

#### Autocalibration

- Select yes /no. If you allow autocalibration, recalibration takes place automatically after every x number of measurements (see: measurements between calibrations).

#### Calibration delayed

- Normally, a calibration is performed after a certain number of measurements. Longer interruptions (e.g. measurements every 6 hours for cell cultivations) can lead to very long periods expiring between the most recent calibration and the next measurement. Activating the delayed calibration function schedules the calibration to be performed shortly before the next measurement. This way, an up-to-date calibration is available.

### Number of measured values in groups

- When using larger measuring intervals, it can make sense to run several measurements with maximum frequency in quick sequence at a given point of time. This way, for example, a group of 10 measurements may be carried out every 6 hours. The number of measured values in the group can be set here. No average is calculated. Every measured value is displayed immediately after measurement. If the time required for the performance of the group is longer than the measurement period, then the next group starts with the new measuring interval.

For the determination of the number of measurements between calibrations, every measurement in a group is taken into account. This must be given due consideration when selecting the calibration settings!

### Standard levels (glucose and lactate)

- Here, you indicate the concentrations of the calibration standard solutions that have been selected and hooked-up for your application.

### Measurements between calibrations

- Here, you can enter how many measurements should be performed before an automatic calibration is run. This feature only works, however, if the autocalibration function has been allowed.



By pressing the "Calibration" button, you can initiate a calibration at any time.  
Any changes made to the automatic calibration data during running operations are not valid until the next calibration.

### Measurements per standard

- This function is used to set the number of measurements per calibration standard. One minute is required for each measurement of a calibration value. That means that a normal calibration with 3 measurements per standard will take 6 minutes (including rinsing times for changing the medium).

### Analog Out Glucose / Analog Out Lactate

- Here, the output of the signals on the analog outputs can be selected between 0-20 mA and 4-20 mA, and between 0-10 V and 2-10 V, respectively (see Figure 89).

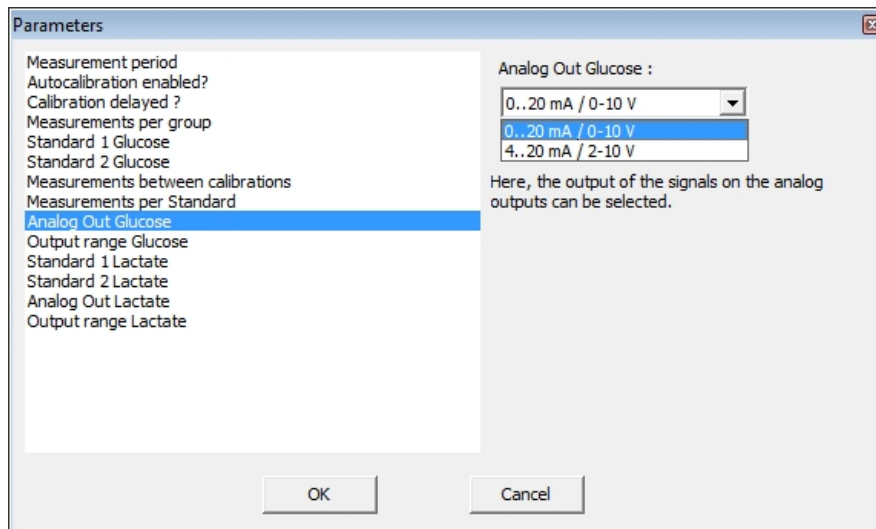

Figure 89: Switching the analog output

### Output range glucose / lactate

- Here, the output ranges of the analog outputs are set. Proceed as follows:  
The upper limit of the measuring range is always indicated. The lower limit is preset to 0.

For a required measurement range of e.g. 0-10 g/L glucose, glucose is set to 10 (upper limit) in the output range.

When selecting the voltage range of 0 – 10 V, then 10 volts are equal to 10 g/L glucose.

### SeMDaP - Data transfer via the serial port

- The TRACE SeMDaP is a protocol for outputting data via an interface. Standard is the serial interface. The protocol contains telegrams of variable length and variable content.
- This function is factory disabled and can be activated here (Figure 90).
- For more details on the protocol, please contact the service.

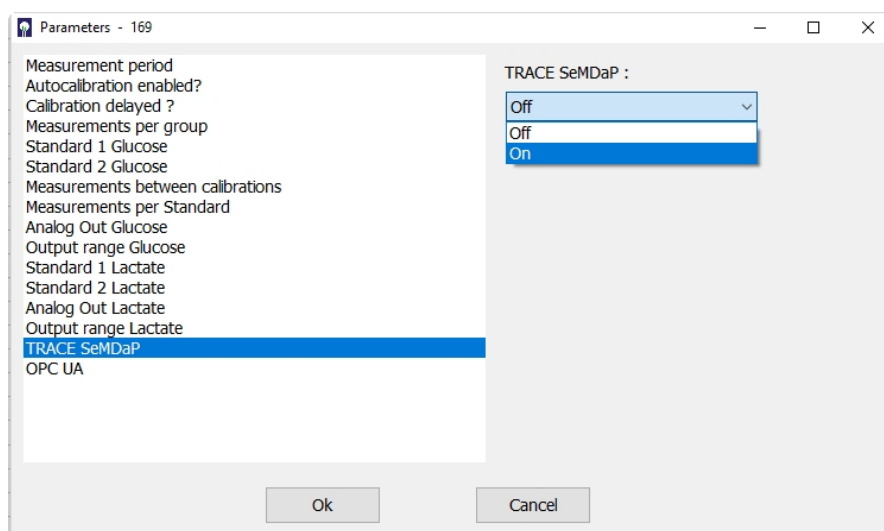

Figure 90: Activating the serial protocol

## OPC UA - Data transfer via TCP/IP

- The device can use the OPC UA format as a server for data transfer to external clients.
- This function is factory disabled and can be activated here (Figure 91).
- For more details on implementing this feature, please contact the service.

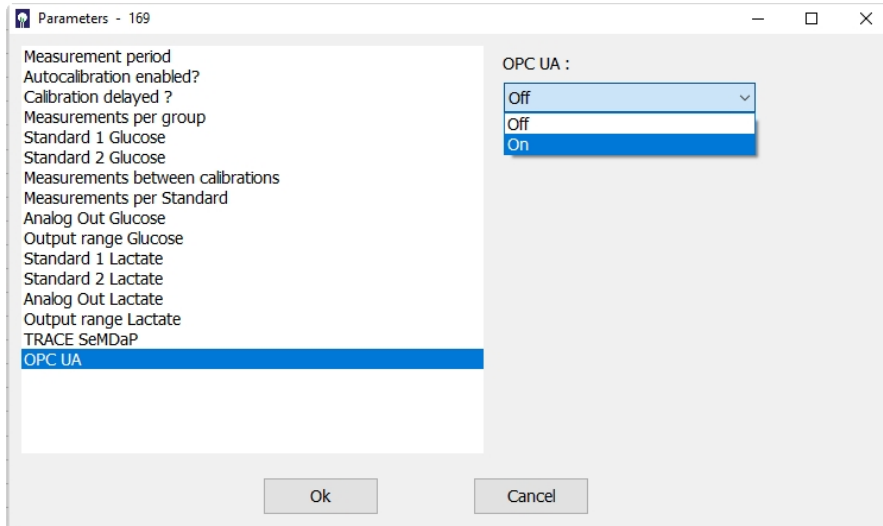

Figure 91: Activating the OPC UA server

### 7.2.4.2 Test ports

For the combination with the ancillary equipment M4 the unit has 4 different test ports (bioreactor probes 1-4). These are controlled by the selection valves on the front of the device. In the case that not all four measuring probes are intended to be used, the respective activation of each port can be specified using the tag input window. The corresponding ports are then differently displayed in the scheduler and in the selection bar of the user interface. The setting also has an effect on the number of displayed graphics.

Test ports	Control Panel	Graphics displayed	Schedule
	 Only probe 1 active		 Only probe 1 active
	 Probe 1 and 4 selectable		 Probe 1 and 4 selectable
	 All probes selectable		 All probes selectable

Figure 92: Selection/activation of ports and resulting displays



TRACE C2 Control has only one test port, therefore the checkboxes are unchecked by default or are not displayed. Only if the ancillary equipment M4 is activated (see chapter "7.2.4.3 Basic settings"), the test port selection fields are also displayed.

In the event that the connection to the auxiliary device M4 is interrupted, the probe field flashes red and thus indicates the fault.

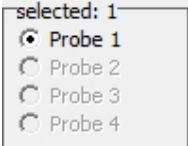
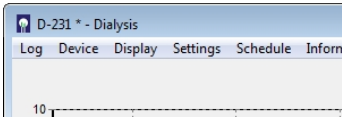
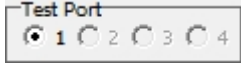
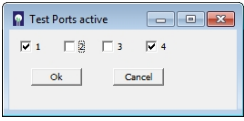
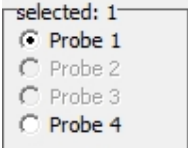
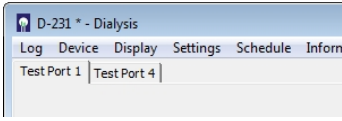
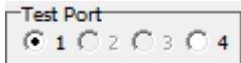
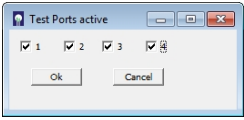
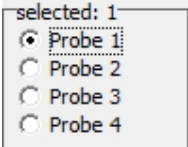
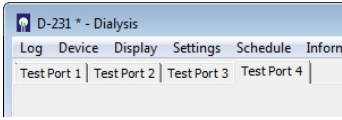
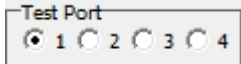
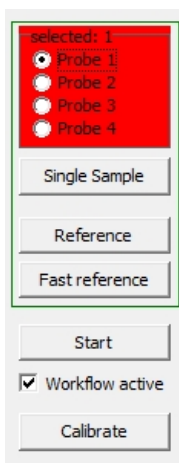
Figure 93: Test port selection fields



### 7.2.4.3 Basic settings

In the “Basic settings” menu item, you can enter data that is important for carrying out and documenting the measurements (Figure 94).

Before running the measurement, you can enter the project name and device location. These information will later be displayed in the header enabling a better assignment of data to the process, especially if several devices are in operation at the same time.

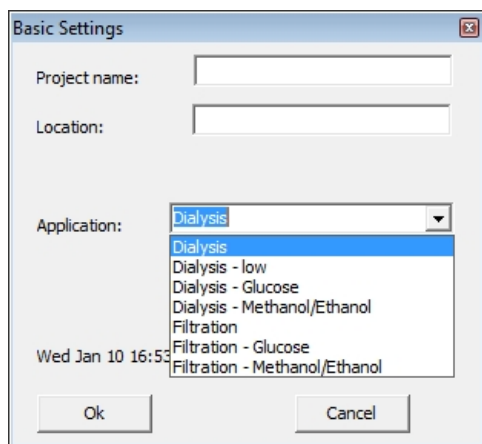

The most important item is the selection of the application used. You can either select filtration or dialysis for the determination of glucose and lactate, as well as filtration-methanol /ethanol and dialysis-methanol/ethanol.

If glucose as sole parameter should be measured the method filtration-glucose or dialysis-glucose can be selected. The lactate measurement channel will be disabled in this application.

Figure 94: Entry screen for basic settings

For the operation in the 4-channel mode with the M4, only the dialysis method and dialysis-methanol/ethanol method are currently available.

	Before working with a new tubing set, always check to make sure that the right application has been selected! Otherwise, this can result in erroneous measurements or destruction of the tubing set!
---	--

By placing a check mark next to “Adjust time”, you can compare the system times on your PC and the device. The device will then use the PC's system time.

In this menu, connected peripherals are also defined. To do this, select "Peripherals" and the input mask shown in Figure 95 opens. The corresponding IP address of the additional device must be entered and confirmed with "Ok" here.

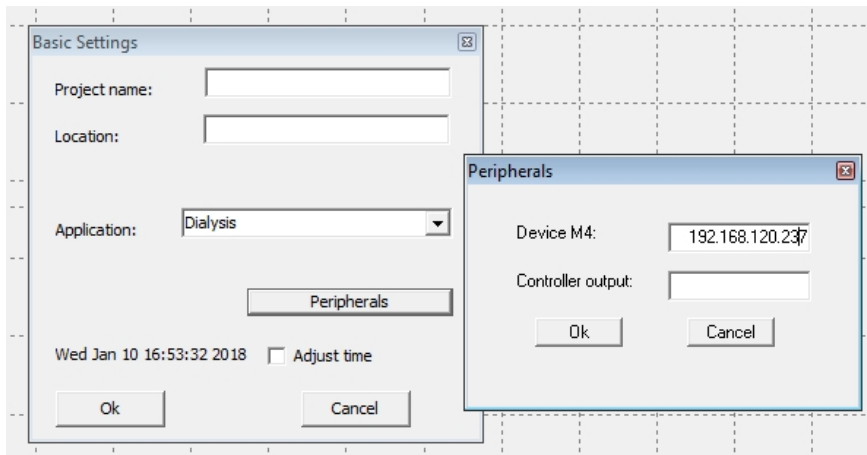



Figure 95: Input mask for setting the IP addresses of peripheral devices.

By deleting the entry, the TRACE C2 is returned to the initial state.

	<p>After connecting or disconnecting a peripheral device, both devices must be turned off and on again to perform a restart. In addition, the PC software trace_mon must be restarted.</p> <p>Otherwise, this can result in erroneous measurements or destruction of the tubing set!</p>
---	--

#### 7.2.4.4 Language



You can select your preferred language under the "Language" menu item (Figure 96). German, English, French, Spanish, Italian and Chinese are available.

Figure 96: Selection window for language settings

## 7.2.5. Menu item „Schedule“

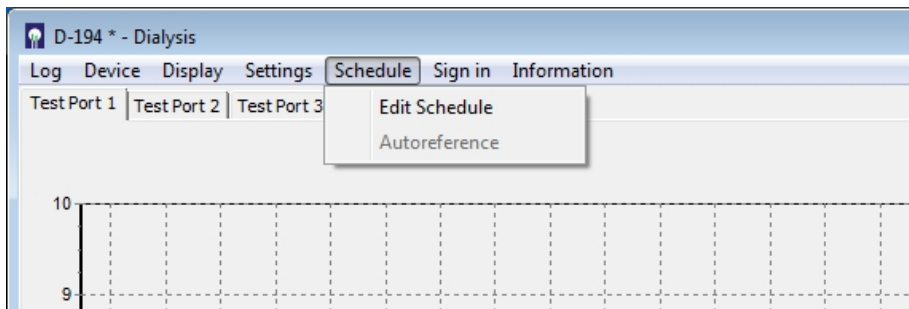

Figure 97: Menu item „Schedule“

Using the menu "Schedule", the device can be individually programmed in its temporal actions. The schedule is divided into the sections "Events" and "Workflow". The schedule can be viewed at any time.

### 7.2.5.1 Edit Schedule

The schedule is divided into the "Events" and "Workflow" areas. The schedule can be viewed at any time.

- **"Events"** are certain actions at fixed time points.
- **"Workflow"** is a cyclically recurring sequence of individual actions that are carried out until the device is placed in standby or completely stopped.

#### 7.2.5.1.1 Events

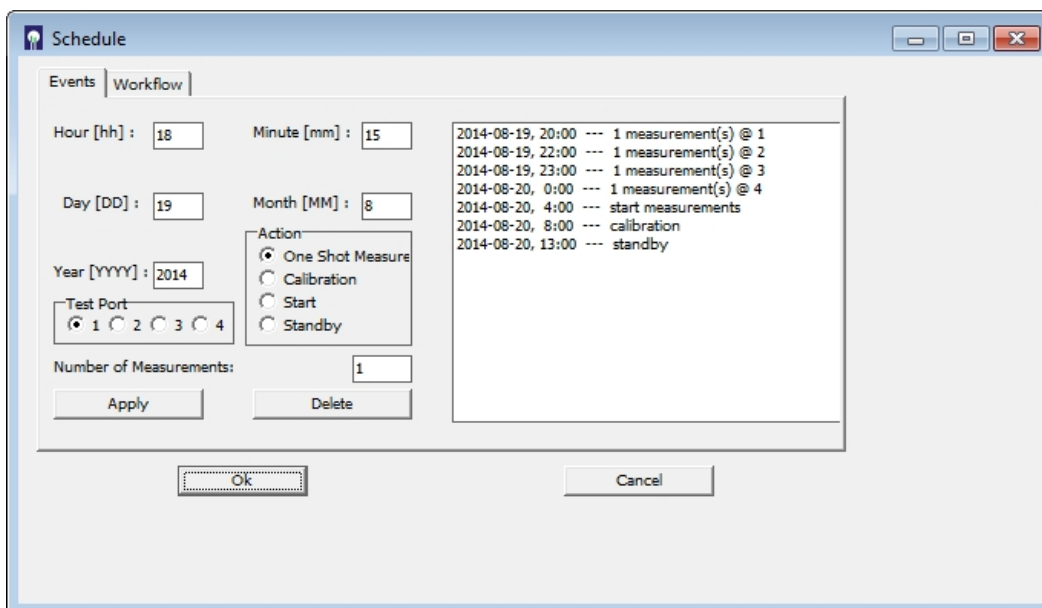

Figure 98: Example entry in the submenu „Events“

In the submenu "Events", individual actions are entered at certain times. For every action (one shot measurement, calibration, start, standby) one or more time points can be determined.

These events are always handled in priority to other actions (from the schedule or the parameter list). In the event that the scheduled time of an action is conflicting with an action of the schedule or in the parameter list, it will wait until this is finished.

It is possible to switch the device at a specific time to start ("Start") and later again in standby ("Standby"). During the measurements either the workflow is executed (if enabled, see below "7.2.5.1.2 Workflow") or the measurement frequency and possibly edited autocalibrations according to the parameter list.

If several measuring ports (M4) are present and enabled, the respective measurements and the desired test port (1-4) can be assigned (see Example entry in Figure 98).

The number of individual measurements (corresponding to "Group" in the parameter list) at the specified time is set via the input field "Number of Measurements".

By pressing the "Apply" button, the settings selected are transferred to the right list box and arranged chronologically. The entry can be marked by clicking on a line and removed from the list again by pressing "Delete". Double entries will be ignored, or at the same time entries only the command above is processed.

Pressing the "OK" button, all records are saved and activated. Press "Cancel" to discard the changes. After a scheduled event was carried out, the entry is removed from the list and does not appear at a later opening of the schedule again. Thus, only the pending events are displayed.

## 7.2.5.1.2 Workflow

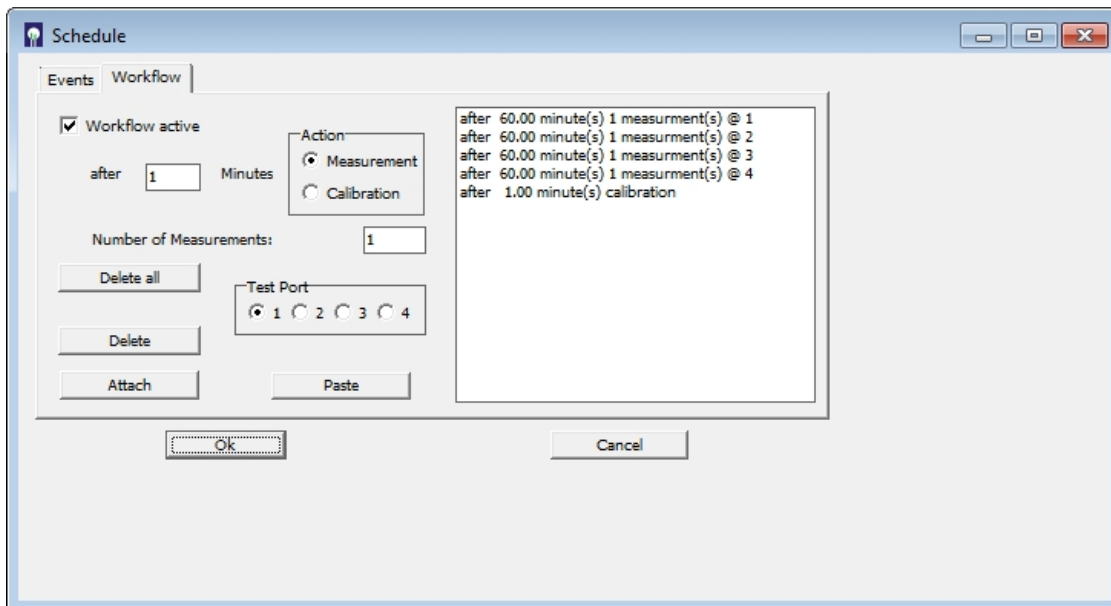

Figure 99: Example entry in the submenu „Workflow“

The sequence of actions is created by registration of the time interval, the desired action (measurement or calibration), the number of individual measurements and the corresponding test port. The time interval between the individual actions is entered in the field "after ... Minutes". If "1" is entered, the next action is performed after a minimum time interval (rinsing of the probe). By choosing larger intervals, the measurement frequency is reduced accordingly.

The workflow is enabled by a check mark "workflow active" in the selection box. If this box is not checked, the measurement processes in the parameter list are processed instead.

The selected action for the first time interval in line 1 is active only during the second pass of the list. This ensures that the processing of the list begins right after the start. On the second pass the selected first time interval in line 1 applies.

The number of individual measurements (corresponding to "Group" in the parameter list) is set via the input field "Number of Measurements". If several test ports (M4) are present and enabled, the respective measurements and the desired test port (1-4) can be assigned (see Example entry in Figure 99).

By pressing the "Attach" button the selected settings are transferred to the right list box and entered in the bottom row. If an action has to be placed between two existing entries, the lower line must be marked.

Then, pressing the "Paste" button inserts the selected setting. The entry can be marked by clicking on a line and removed from the list again by pressing "Delete".

Pressing the button "Delete all" all entries will be deleted from the list box.

Pressing the "OK" button, all records are saved and activated. Press "Cancel" to discard the changes.

The workflow is executed cyclically as long until the unit is stopped or put into standby.

#### 7.2.5.2 Autoreference (Dialysis mode only)

In the case of several connected probes (via the ancillary equipment M4), the fast reference can be carried out automatically for selected test ports.

To do this, the menu item "Autoreference" in the main menu "Scheduler" is selected. The function can only be reached from the standby state of operation. The input field shown in Figure 100 appears, where all probes are activated by a checkmark after the input field. Test ports that are not in operation are not displayed.

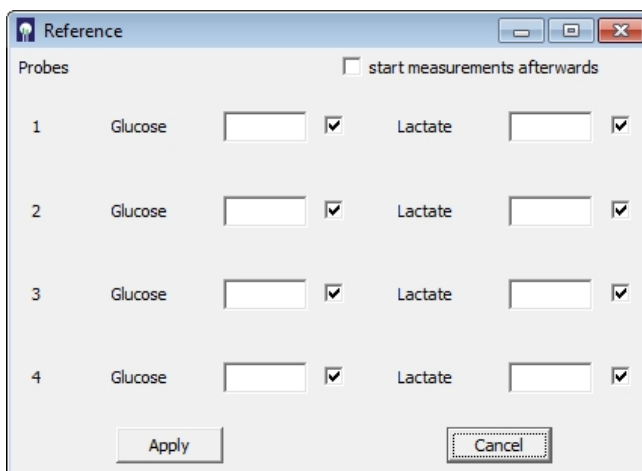

Reference						
Probes						
<input type="checkbox"/> start measurements afterwards						
1	Glucose	<input type="text"/>	<input checked="" type="checkbox"/>	Lactate	<input type="text"/>	<input checked="" type="checkbox"/>
2	Glucose	<input type="text"/>	<input checked="" type="checkbox"/>	Lactate	<input type="text"/>	<input checked="" type="checkbox"/>
3	Glucose	<input type="text"/>	<input checked="" type="checkbox"/>	Lactate	<input type="text"/>	<input checked="" type="checkbox"/>
4	Glucose	<input type="text"/>	<input checked="" type="checkbox"/>	Lactate	<input type="text"/>	<input checked="" type="checkbox"/>

Apply Cancel

Figure 100: Input field for autoreference

Enter the known concentration values for the probes to be referenced in the table.

For test ports, which are in operation but whose probes should not be referenced, you must remove the checkmarks. Empty fields are invalid entries and must therefore also be deactivated. If not, the autoreference can not be started ("Apply" does not show any effect in this case).

Pressing the "Apply" button starts the autoreference. "Cancel" aborts the operation. If desired, the pre-set measurements can be started automatically after completion of the reference measurements (for example, according to the workflow). In this case, the "start measurements afterwards" checkbox must be set.

## 7.2.6 Menu item „Controller“

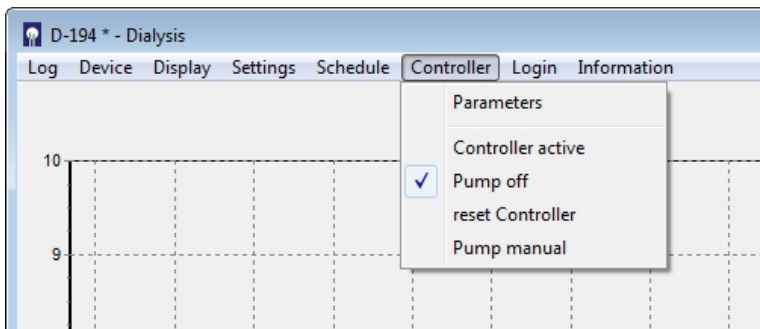

Figure 101: Menu Options "Controller"

The integrated controllers (PID-controller and Minimum-Maximum-controller) can be configured and operated in the menu "Controller". The controllers can directly drive external pumps (via the serial interface or analog output 3 on the back of the device) as feeding pumps. If no external pump is available, the built-in side-mounted feeding pump of the device can be used.

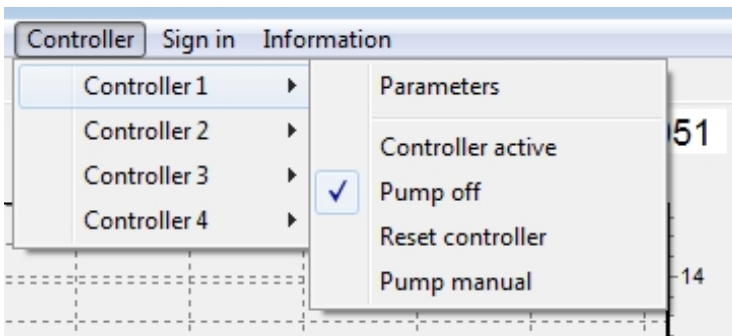
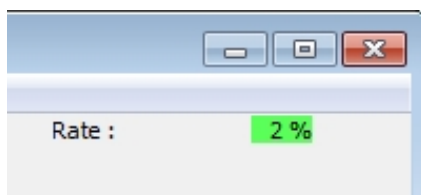

Figure 102: Setting for 4 controllers

For the ancillary equipment M4 a 4-channel controller is available. For connection to feeding pumps please contact your customer service.

On the display a box with the indication of the current feed rate (0-100%) of the feeding pump appears when the pump is active.



A green background indicates an active controller.

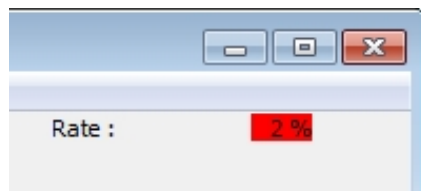

The background turns red when the controller is inactive.

Figure 103: Controller aktive (green) / inactive (red)

The respective feed rates are recorded in the bpd-file (see chapter "7.2.1 Menu item „Log“).



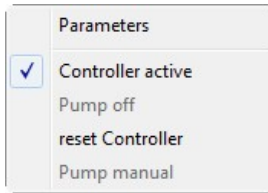

If "controller active" is selected, the built-in device controller is switched on and the feeding pump is activated. While the controller is active, the pump cannot be switched off or operated manually.

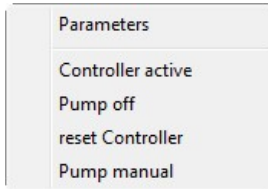

To disable the controller, the check mark must be clicked. In this state, the controller is inactive, but the feeding pump is still running at the rate specified by the last controller on.

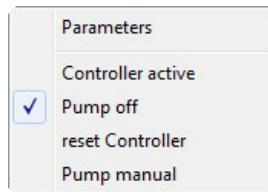

With "pump off" the feeding pump is switched off manually. You can then turn on again only by the re-activation of the controller.

In order to avoid a too high influence of the integral gain on the PID-controller at the beginning, the integral gain can be reset to the pre-set value by "reset Controller" at any time.

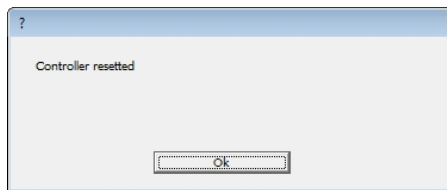

This command must then be confirmed with "Ok". This function has no effect on the Minimum-Maximum-controller.

"Pump manually" is a function that can be used for filling the feeding tube. In this operating window, the pump rate can be adjusted and the pump is started or stopped. By "Exit" or close the window, the pump is automatically stopped.

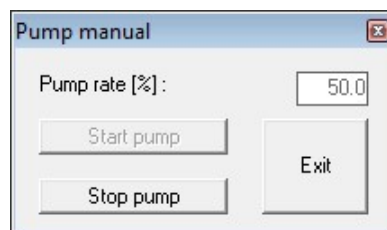
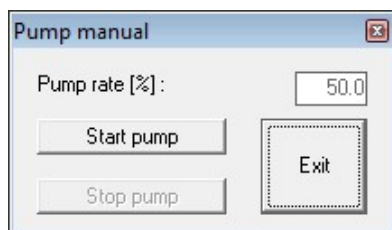

Figure 104: Manual pump operation

The respective type of control can be selected between PID-control and Minimum-Maximum-control in the sub menu "Parameters" under "Type of controller".

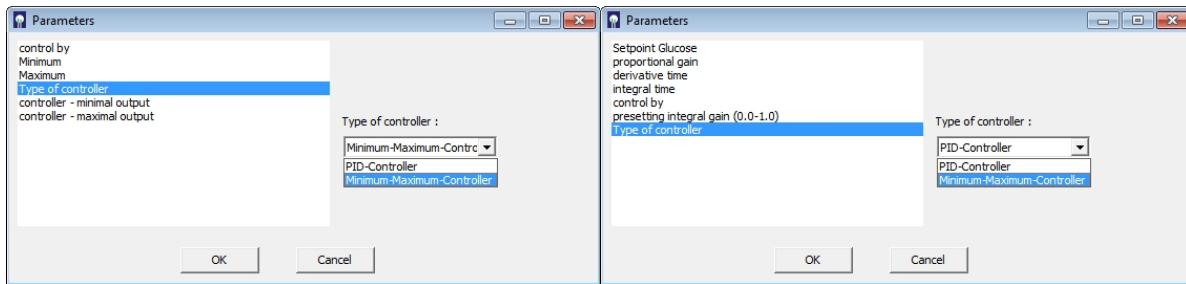

Figure 105: Options in controller sub menu "Parameters" (left PID, right Minimum-Maximum)

### 7.2.6.1 PID-Controller

After selecting the type of controller to PID-controller in the submenu "Parameters" the "Setpoint Glucose" is registered for the control. Moreover, here the control parameters "proportional gain", "derivative time" and "integral time" can be entered. In the option "control by" it can be selected if the control acts to the integrated pump or an external pump via the serial interface or analog output 3.

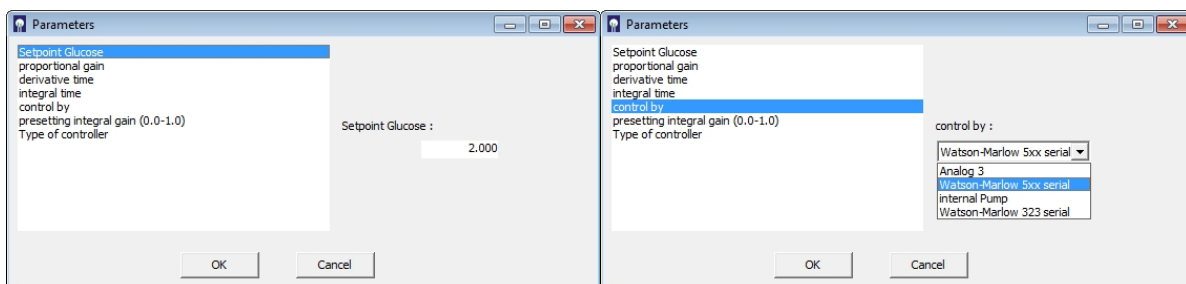
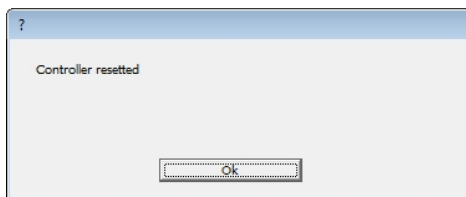
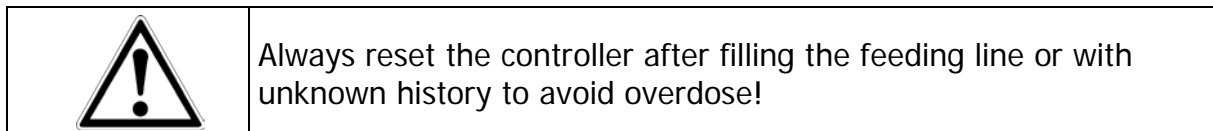

Figure 106: Display options in PID-controller sub menu "Parameters"



In order to avoid a too high influence of the integral gain on the controller at the beginning, the integral gain can be reset to the pre-set value by "reset Controller" at any time. This command must then be confirmed with "Ok".



Recommended start settings for the PID-Controller:

- For **microbial cultures** the following settings can be recommended:  
P = 0.1 - 0.5 (proportional gain). Depending on the concentration of the feeding solution, max. pump speed, diameter of the tubing, reactor volume, etc.,  
I= 45 min (integral time),  
D= 2 min (derivative time).
- For **cell cultures** the following settings can be recommended:  
P = 0.01 - 0.1 (proportional gain). Depending on the concentration of the feeding solution, max. pump speed, diameter of the tubing, reactor volume, etc.,  
I= 60 min (integral time),  
D= 1 min (derivative time).
- In most cases adjustment of the P-value and you can let the I-value and D-value at the recommended level.
- If the feeding is too strong reduce the P-value or if it is not enough increase the P-value.

#### 7.2.6.2 Minimum-Maximum-Controller

After selecting the type of controller to Minimum-Maximum-controller in the submenu "Parameters" the "Minimum" and "Maximum" limits are registered for the control.

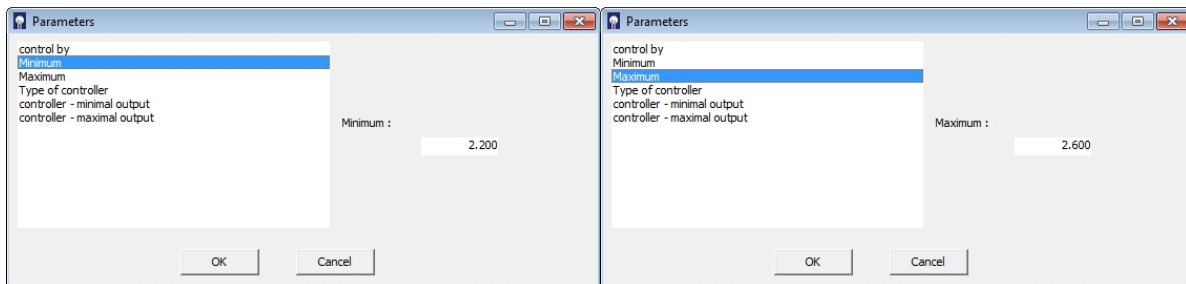

Figure 107: Display options in Min-Max-controller submenu "Parameters"

The Minimum-Maximum-controller switches the feeding pump if it is above or below the limits respectively to the minimum flow rate, or maximum flow rate.

The minimum delivery rate and the maximum flow rate of the pump can be specified with the setting "controller – minimal output" and "controller – maximal output". The default settings are preset to 0% and 100%.

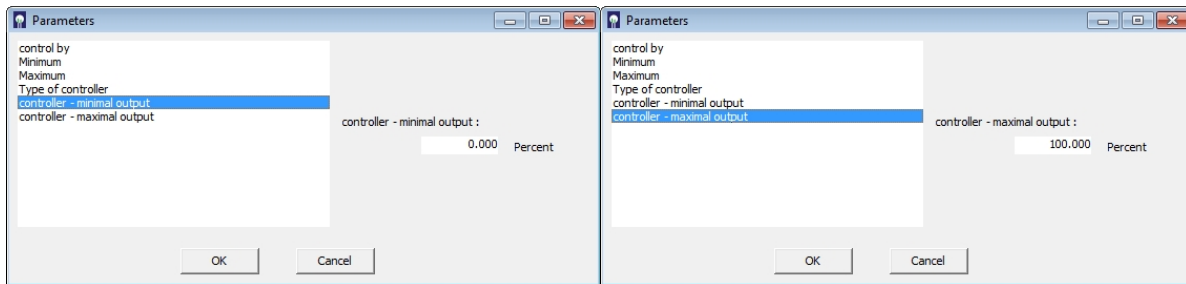
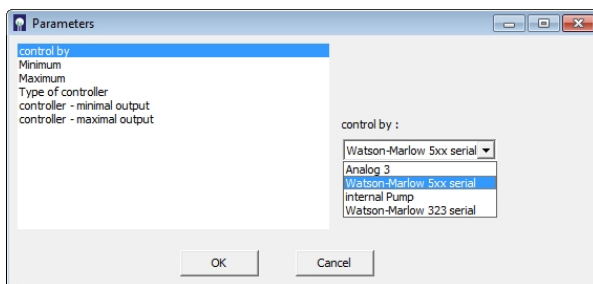

Figure 108: Min-Max-controller - Definition of Min- and Max-value



In the option "control by" it can be selected if the control acts to the integrated pump or an external pump via the serial interface or analog output 3.

Figure 109: Min-Max-controller - Selection of control pump

### 7.2.7 Menu item „Login“

This menu can set up a server management that allows different access rights depending on the responsibility of the user.

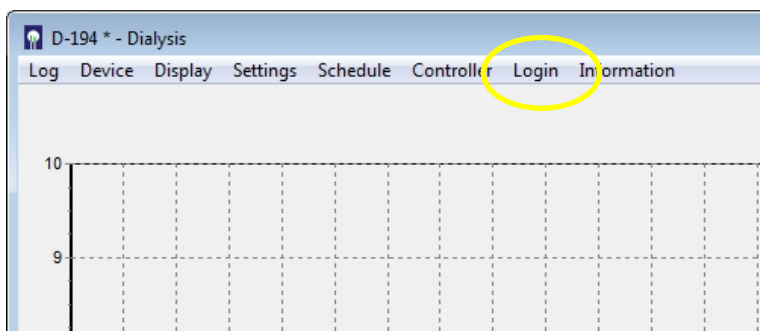

Figure 110: Menu item „Login“

This menu item is only activated when the program was started with the launch setting "-L" (see chapter "6.5.1 Activate access restriction / Login"). The device opens then when you first start the Administrator mode. The administrator then creates other operators and gives them the access rights (group 0-2). For all subsequent starts initially only the lowest access level (group 0) is active and the respective operator must authorize himself using the menu item "Login"

The assignment of preset access rights to the respective groups are shown in Table 8.

<i>Menu function</i>	<i>Administrator</i>	<i>Responsible</i>	<i>Operator</i>	<i>All</i>
Name	admin			
Password	trace			
Group	6	2	1	0
Log	+	+	+	
New	+	+	+	
Open..	+	+	+	
Device	+	+	+	
Connect	+	+	+	
Setting-up operation	+	+	+	
Cleaning	+	+	+	
Stop	+	+	+	
Display	+	+	+	+
Print diagram	+	+	+	+
Calibration values	+	+	+	+
Reset reference	+	+	+	
Calibration history	+	+	+	+
Status	+	+	+	+
Settings	+	+	+	+
Parameters	+	+	+	
Test ports	+	+	+	
Basic settings	+	+	+	
Language	+	+	+	+
Schedule	+	+	(view only)	(view only)
Controller	+	+		
Parameters	+	+		
Controller active	+	+		
Pump off	+	+		
reset Controller	+	+		
Pump manual	+	+		
Login	+	+	+	+
New	+			
Delete	+			
Login	+	+	+	
Change password	+	+	+	
Information	+	+	+	+
Function Keys (Basic Commands)	+	+	+	

Table 8: Overview of access rights

### 7.2.8 Menu item „Information“

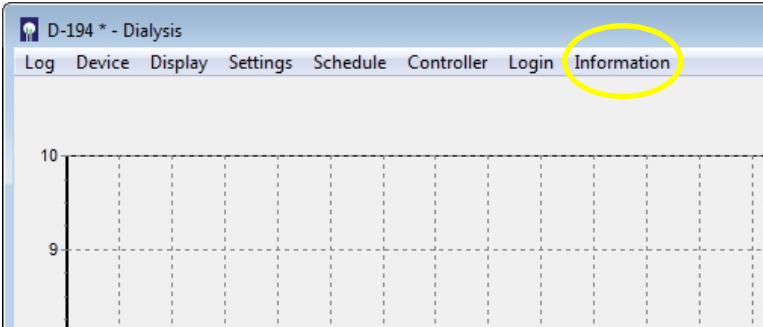

Figure 111: Menu item „Information“

Select the menu item “Information” to display the current software versions of the device and the control software trace\_mon as well as the serial no. of the device.

## 7.3 LED Status Messages

In order to be able to read the device status independently of the operating software on a connected PC directly on the device, the various operating statuses can be read using the LEDs on the front. The following Table 9 provides an overview of the LED signals:

Status	Action	LED left (green)	LED right Color	LED right Status
<b><i>Setting-up operation and decommissioning</i></b>				
Boot process		on	white	on
Stop		on	cyan	on
Filling		on	cyan	flashes
Preliminary measurement		on	green/cyan	flashes
Cleaning		on	magenta/cyan	flashes
<b><i>Measurement</i></b>				
Measurement	loaded	on	green	on
Measurement	unloaded	on	green	flashes
<b><i>Breaks in measuring</i></b>				
Readiness	readiness	on	yellow	on
Interval	standstill	on	yellow	flashes
<b><i>Rinsing cycles</i></b>				
Changing the medium		on	magenta	on
Rinsing probe		on	magenta	flashes
<b><i>Calibrations</i></b>				
Calibration	loaded	on	blue	on
Calibration	unloaded	on	blue	flashes
Reference	loaded	on	blue	on
Reference	unloaded	on	blue	flashes
<b><i>Faults</i></b>				
No network connection		on	red	on
Initialisation error		on	black	off
No peripherals connection		on	Xx/violet	flashes

Table 9: LED status messages



The following Table 10 gives an overview of the LED signals on the ancillary equipment M4:

Status	Action	LED left (green)	LED right Color	LED right Status
<b><i>Setting-up operation and decommissioning</i></b>				
Boot process		on	white	on
Network connection		on	green	on
<b><i>Faults</i></b>				
No network connection		on	red	on
Initialisation error		on	black	off

Table 10: LED status messages ancillary equipment M4

## 8 Tips and checklist

### 8.1 Choosing suitable standard solutions

Various combinations of calibration standard solutions are available to optimally cover the expected concentration cycles. We recommend connecting the higher concentrated solution as standard 1, because standard 1 is used to warm-up the sensor during initial priming. This process is more effective if higher signals are produced by the enzymatic action.

Depending on the process conditions and the objective of the cultivation, various concentration ranges have to be covered. The concentration range should principally be between the concentrations of the standard solutions in order to ensure optimal measuring accuracy. Furthermore, we recommend always choosing a standard with very low concentration in order to properly determine measured values close to zero.

For control, the concentrations of the calibration standards should not be too far from the control (set) point. For control at 1g/l, for example, it is more practical to use a combination of 0.5 g/l and 4 g/l than a combination of 1 g/l and 10 g/l.

### 8.2 Dialysis mode: Reference measurements at the start of fermentation

It is crucial to perform reference measurements when using the dialysis method to compare the permeability of the membranes inside the reactor and outside the diffusion cell as well as to compensate for temperature differences between both membranes.

Thus, reliable determination of the reference factor is very important for the quality of the measured values.

It is therefore recommended that you determine the reference value as soon as possible at the start of the cultivation and do so in a phase without fluctuations in the concentration of the medium.



Since the sensitivity of the sensor further increases within the first 12 hours, it is advisable to repeat the process of calibration and referencing after some time in order to achieve optimal results.

For this purpose, deactivate autocalibration and then set the measuring interval to 1. Afterwards, track some measured values. If they do not spread too widely and are as constant as possible, you can trigger reference measurement.

Once the reference measurements are completed, you should wait for some measurements and check if the recalculated values meet your expectations.

If necessary, you can also repeat the reference measurement. As soon as you are satisfied with the result, you can readjust the measurement parameters and start with the cultivation.

### 8.3 Dialysis mode: Reference measurements for low lactate concentrations

In many cases, there is a surplus in glucose and the medium is (still) lactate-free at the start of a cultivation. When performing reference measurements, the device suggests a value once the reference measurement is completed. This value is usually overwritten by entering the known value (known due to the media composition or determined with an external analyser). If the available lactate concentration is still very low, do not yet overwrite this value (the reference factor for lactate then remains at 1.0). During the course of the cultivation, the increase in lactate concentration can now be observed more easily. In due course, a standard reference measurement overwriting both values can be performed.

### 8.4 Avoiding contamination in the tubing set

During longer processes (over a period of weeks), biofilm contamination can form inside the tubing set over time. This can result in the lines clogging or in highly fluctuating measured values. This applies in particular to storage tanks with ready-for-use diluted transport solution that are repeatedly refilled with fresh solution. It is advantageous to completely replace the almost-empty container with a new container with fresh solution to avoid a transfer of microbes.

In some long-term cultivations, it was observed that biofilm would form in the waste line and spread into the drip chamber. In this case, it is also recommendable to regularly replace the waste containers and to prevent the waste line from being immersed in the waste. The waste containers can be further protected by adding disinfectant solution.

Some users reported that the probe does not give a signal, whilst the calibration is unaffected. This is a typical sign for a contamination inside the probe.

How can microbes enter the probe? These are potential sources of error:

- 1) the adapter lines (Luer-UNF) – not cleaned or disinfected prior to use
- 2) Transport Buffer – prepared in a contaminated bottle or stock bottle is refilled
- 3) Tubeset (reused) – not cleaned and disinfected properly
- 4) Waste line/Waste container – waste line submerged in liquid. No disinfectant added to the waste bottle and/or left open.
- 5) Probe sterilisation – improper sterilisation or infection by flushing with syringe.

Advise:

To 1) Do not forget to flush the adapter lines with cleaning solution. Normally this happens when the tubeset is cleaned after use with probes connected ("7.2.2.3 Cleaning"). If probes are disconnected earlier, the adapter lines may not be properly cleaned. And then if reused (since they can not be sterilized with the probes) can be a source of infection.

You can flush each adapter line with 5 mL of isopropanol prior to installation, but please avoid longer contact - since the glue in the connector may dissolve (when in longer contact or submerged in isopropanol).

To 2) Use clean containers/bottles for transport buffer. Do not refill with fresh solution, but replace the container. Ideally sterile filter the buffer (that is what cell culture and GMP facilities typically do).

To 3) Clean the tubeset according to the recommendation (see chapter care and maintenance "10.2 Tubing set"). Use cleaning solution. Additional rinsing of the tube set with cleaning solution prior to calibration and attachment of probes may be advisable.

To 4) Add some KOH or NaOH pills or chemical disinfectant into the waste container. Use parafilm or other to close the container.

To 5) Check if a contamination post sterilisation could have happened. A typical error is to use an unsterile liquid for flushing the probe after sterilisation. In combination with a contaminated adapter line this is the most probable case.

## 8.5 Making best use of the enzyme reactor

The enzyme reactor contains immobilized enzyme, in which the protein is held in place and therefore can be used for a longer period of time. Nevertheless, there are some things that can reduce its catalytic activity and therefore need to be considered.

These are:

- a) temperature
- b) air
- c) inhibitors
- d) substrate/product(s)
- e) pH and ionic strength

to a) Since the enzyme is a protein it can be denatured by temperature. Usually, the higher the temperature, the more the enzyme suffers, up to complete inactivation. Low temperature can also have an effect on the enzyme catalytic activity, so if the ambient temperature is too low the substrate conversion may be low and the signal gets low as well. Freezing will cause a denaturation and lost activity as well. We recommend an operational temperature at 20-25°C and storage (in buffer) at 4-8°C.

(Note: The temperature of the sampling probe in the bioreactor can be higher without any problems).

To b) If air enters the enzyme reactor and the immobilized material dries out, this causes a denaturation of the protein and the activity will be lowered or lost. Always keep enzyme wetted with transport buffer.

To c) There is a known irreversible inhibitor of the alcohol oxidase which is the chloride ion. Please avoid to flush the enzyme reactor with chloride containing buffers. There is a special transport buffer for the ethanol/methanol method that is chloride-free (see 4.2.6 Transport buffer).

To d) if the enzyme reactor is left with residual ethanol/methanol this will be converted into hydrogen peroxide, which will denature the enzyme. Please flush the enzyme reactor properly with transport buffer prior to storage. Keep it submersed in buffer and store in the fridge (no freezing!)

To e) wrong pH and strong or weak ionic strength will also damage the enzyme. Do not use just distilled water for flushing or storage - use transport buffer!  
If you want to use the reactor for several fermentations, we recommend to flush the enzyme reactor properly with transport buffer and keep it in the fridge when not in use. Make sure it is submersed in buffer and can not dry out. When reinstalling make sure the tubeset has been completely flushed to avoid contact with residual air which could damage the enzyme.

Tips:

- Avoid air in the tubeset (priming first - then installation of enzyme reactor)
- Flush and store in transport buffer / submersed
- Store in the fridge (4-8°C)
- Do not dry out
- Do not freeze
- Do not heat
- Do not use chloride buffers

## 8.6 Import data to Excel

The measured values of the device are saved on the PC as bpd file. For further processing, the data can be imported using a macro or manually into Excel.

### 8.6.1 Data transfer to excel using an excel macro

The data can be transferred to excel using the macro "Macro\_bpd.xlsm".

This macro is stored in the device's data memory and can be accessed via the internal device website (see chapter "6.3 Loading the software and network connection"). This macro automatically creates a table and a graph.

**How to use this Macro:**

This Macro will open a bpd-file. After starting the Macro with the key combination **Ctrl + M** you have to select a bpd-file.

The Macro will transfer the data into an Excel-sheet and generate a graph.

Figure 112: Instructions for the use of the macro

Procedure:

1. open "Macro\_bpd.xlsm"
2. start macro with "Ctrl+M"
3. creates a file with table and graph

Date	Time	Reactor No.	Temperature	Glucose	Lactate	Feed pump sp	Time of Exp.
23.04.2015	09:13:59	0	25,800	0,840	0,280	1,000	0,000
23.04.2015	09:15:59	0	26,000	0,890	0,220	1,000	0,033
23.04.2015	09:17:59	0	26,200	1,920	0,210	0,828	0,067
23.04.2015	09:19:59	0	26,300	2,700	0,200	0,633	0,100
23.04.2015	09:21:59	0	26,400	3,500	0,200	0,322	0,133
23.04.2015	09:23:59	0	26,400	3,940	0,190	0,288	0,167
23.04.2015	09:25:59	0	26,500	4,150	0,190	0,289	0,200
23.04.2015	09:27:59	0	26,500	4,380	0,190	0,185	0,233
23.04.2015	09:29:59	0	26,600	4,500	0,190	0,171	0,267
23.04.2015	09:31:59	0	26,700	4,580	0,190	0,146	0,300
23.04.2015	09:33:59	0	26,800	4,580	0,190	0,165	0,333
23.04.2015	09:35:59	0	26,900	4,640	0,190	0,112	0,367
23.04.2015	09:37:59	0	26,900	4,560	0,190	0,182	0,400
23.04.2015	09:39:59	0	27,000	4,560	0,190	0,145	0,433
23.04.2015	09:41:59	0	27,100	4,600	0,190	0,101	0,467
23.04.2015	09:43:59	0	27,200	4,600	0,190	0,106	0,500
23.04.2015	09:45:59	0	27,300	4,450	0,190	0,224	0,533
23.04.2015	09:47:59	0	27,300	4,370	0,180	0,216	0,567
23.04.2015	09:49:59	0	27,300	4,420	0,190	0,134	0,600
23.04.2015	09:51:59	0	27,300	4,540	0,190	0,055	0,633
23.04.2015	09:53:59	0	27,300	4,370	0,180	0,229	0,667
23.04.2015	09:55:59	0	27,400	4,360	0,190	0,165	0,700
23.04.2015	09:57:59	0	27,500	4,410	0,190	0,113	0,733
23.04.2015	09:59:59	0	27,500	4,350	0,190	0,174	0,767
23.04.2015	10:01:59	0	27,600	4,260	0,180	0,212	0,800
23.04.2015	10:03:59	0	27,600	4,150	0,180	0,264	0,833

Table 11: Tabular overview of the experiment

In addition to the date and time the respective data for temperature at the measurement cell, glucose reading and lactate reading will be logged. If the controller is active, the respective feed rate (1 = 100%) is recorded. If the device is in the M4 mode, the port for which the values apply is referred to in column 3 (the numbering starts at 0 for test port 1).

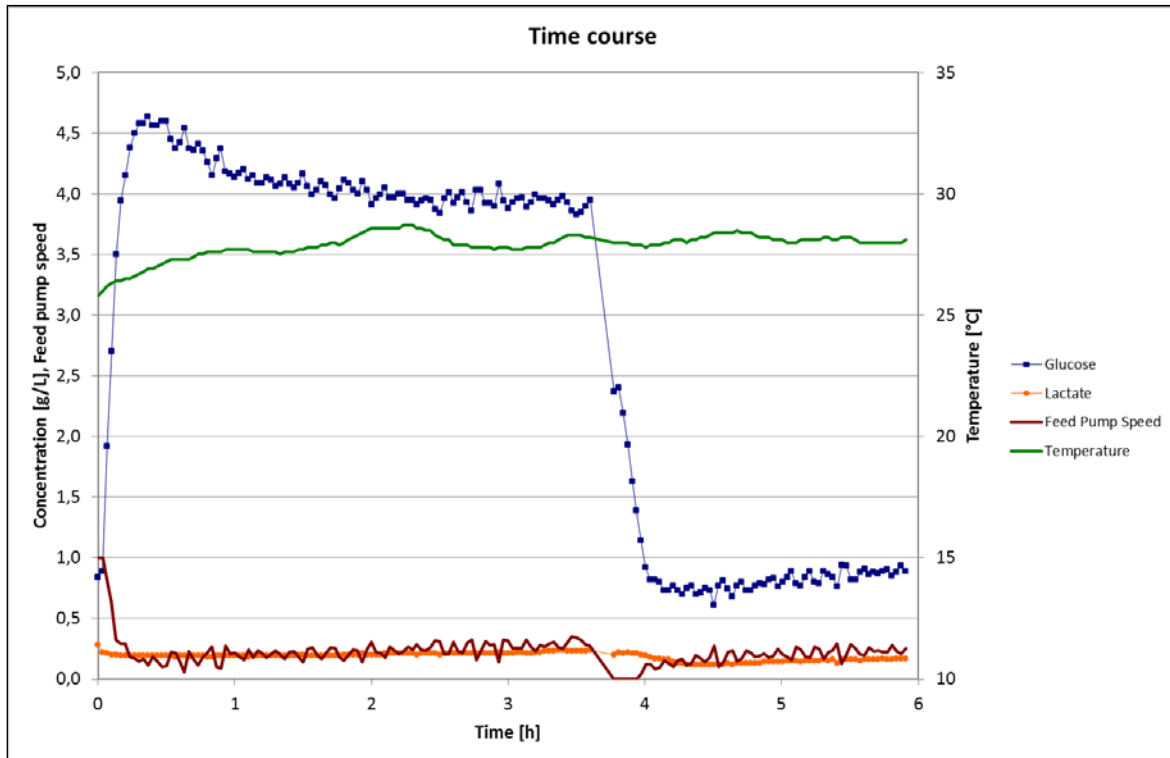

Figure 113: Graphical overview of the experiment



## 8.6.2 Manual data import to Excel

The data import of the bpd file into Excel is carried out in seven steps:

1. Open the MS Excel program.
2. Select „File“/ „Load“ and select the directory in which the bpd file is saved.
3. Activate „All files“ (circled in orange)

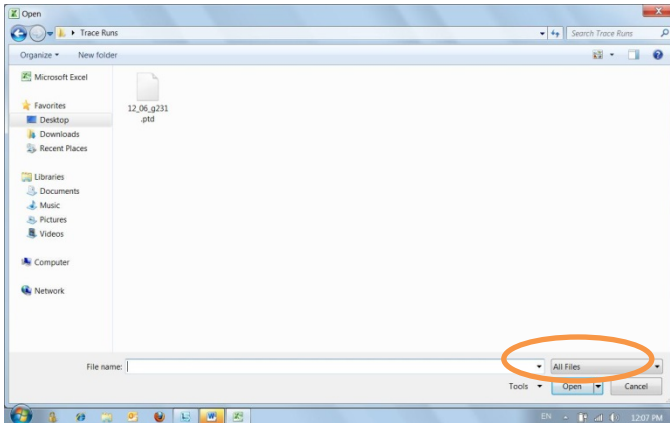

Figure 114: Importing data from the bpd file into Excel. Activate „All files“

4. Highlight the bpd file (circled in orange)
- Confirm your selection by pressing the „Load“ button (circled in red)

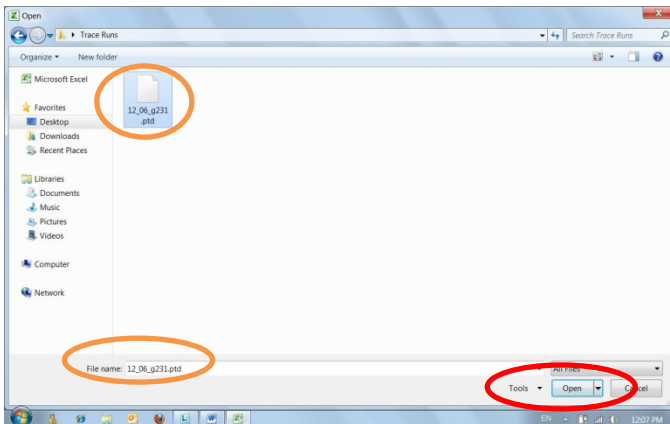

Figure 115: Import data of the bpd file into Excel „Highlighting the bpd file“

5. Text conversion assistant (step 1)

The text conversion assistant will then start. The file is read in three steps. First, select the field “Separated” (circled in orange). This step is completed by pressing the “Next” button (circled in red).

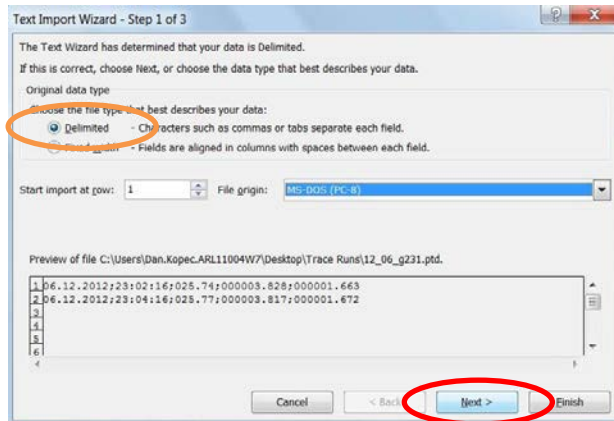

Figure 116: Import data from the bpd file into Excel, text conversion assistant step 1

### 6. Text conversion assistant (step 2)

In this step, the “Semicolon” separator is selected (circled in orange) and confirmed by pressing the “Next” button (circled in red).

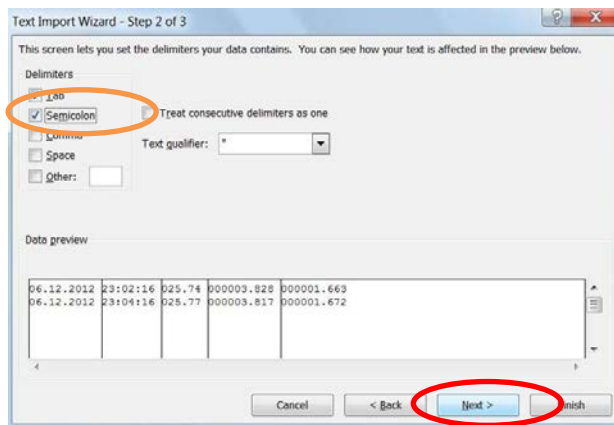

Figure 117: Import data from the bpd file into Excel, text conversion assistant step 2

### 7. Text conversion assistant (step 3)

In this step, the “More” option is selected (circled in orange).

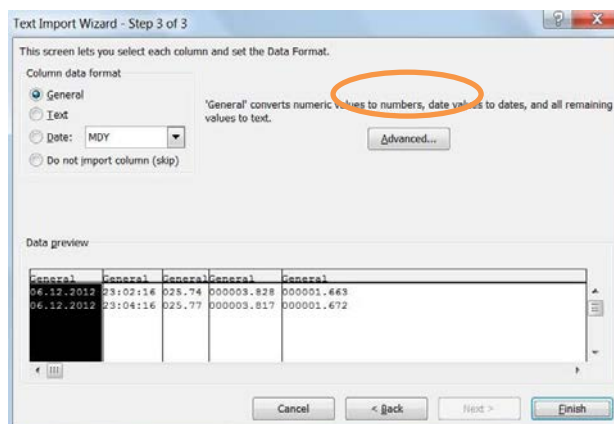

Figure 118: Import data from the bpd file into Excel, text conversion assistant step 3

Here you can select “More text import options”. A period “.” is set as the decimal separator and a space as the separator for thousands (circled in red).

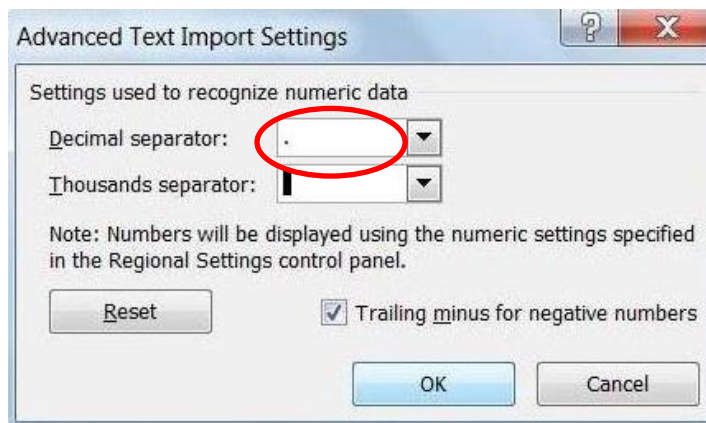

Figure 119: Import data of the bpd file into Excel „More text import options“

After confirmation of this window with "OK" confirm step 3 of the text import wizard with "Finish". The data of the bpd file are now in an Excel spreadsheet (see Table 12).

Date (dd.mm.yyyy)	Time	Port (1-4) / 0=1	Temperature (°C)	Channel 1 Glucose (g/L)	Channel 2 Lactate (g/L)	Feed- Rate % (/100)
05.08.2014	14:30:47	0	31,04	4,702	1,48	1
05.08.2014	14:32:47	0	31,04	4,688	1,475	1
05.08.2014	14:34:47	0	31,04	4,683	1,521	1
05.08.2014	14:36:47	0	31,07	4,665	1,49	1
05.08.2014	14:38:47	0	31,07	4,693	1,457	1
05.08.2014	14:40:47	0	31,04	4,663	1,477	0
05.08.2014	14:42:47	0	31,04	4,626	1,447	0
05.08.2014	14:44:47	0	31,04	4,686	1,455	0
05.08.2014	14:46:47	0	31,04	4,699	1,434	1
05.08.2014	14:48:47	0	31	4,674	1,511	1
05.08.2014	14:50:47	0	31	4,726	1,473	1
05.08.2014	14:52:47	0	31	4,656	1,46	1

Table 12: Sample data of a bpd file / method filtration glucose/lactate

In addition to the date and time the respective data for temperature at the measurement cell, glucose reading and lactate reading will be logged.

If the controller is active, the respective feed rate (1 = 100%) is recorded.

If the device is in the M4 mode, the port for which the values apply is referred to in column 3 (the numbering starts at 0 for test port 1).

## 8.7 Checklist

Step	Action	Chapter	Page	Figure	Check
0	Install PC software (only on initial setup)	6.3 Loading the software and network connection and 6.4 Installing the PC-software	71	Figure 63	
	Access website of the device		72	Figure 64	
	Download the installation program		72	-	
	Start the installation program	6.4 Installing the PC-software	74	-	
	Adjust IP address and subnet screen		73	Figure 65	
1	Prepare the probes	6.2.7 Connecting the dialysis probe and 6.2.8 Connecting the filtration probe	60ff	Figure 49- Figure 62	
	Install the dialysis membrane	6.2.7.1 Mounting the dialysis membrane in the dialysis probe	60	Figure 49- Figure 52	
	<b>For filtration only:</b> Hydrophilize the membrane with Isopropanol	6.2.8.1 Hydrophilizing the polypropylene membrane	68ff	Figure 59- Figure 61	
	Install the probe in the reactor (and sterilize, if necessary)	6.2.7.2 Installing the dialysis probe into the bioreactor	62ff	Figure 53- Figure 56	
2	Prepare transport buffer and waste container	6.2.3 Tubing on the device and 8.4 Avoiding contamination in the tubing set	49/1 15	-	
	Dilute buffer concentrate and prepare in bottles	6.2.2 Preparation of transport buffer solution	48	-	
	Prepare waste container with disinfecting agent, if necessary	8.4 Avoiding contamination in the tubing set	115	-	
3	Setup device tubing	6.2.3 Tubing on the device- 6.2.5 Attaching the tubing set for the „dialysis“ operating mode	49- 56	Figure 26- 45	
	Align and slightly open guide plate		51ff	Figure 28	
	Insert and pull down valve tubes into valve slot		52	Figure 29- Figure 32	
	Push guide plates in direction of valves for protection		53	Figure 32	
	Insert and engage pumps		53	Figure 33- Figure 34	
	Place measurement cell into recess and affix with knurled screw		54	Figure 36- Figure 37	
	Attach diffusion module		55	Figure 38	
	Insert drip counters		55	Figure 39	
	<b>For M4 only:</b> Insert selecting valve tubes 1-4 and pumps (optional)	6.2.5.1 Ancillary equipment M4	56	Figure 41- Figure 45	
	<b>For dialysis only:</b> Connect three-way stopcock (optional)	6.2.5 Attaching the tubing set for the „dialysis“ operating mode	56	Figure 40	
4	Connect inlet and outlet lines	6.2.3 Tubing on the device	49	-	
	Connect tubing to transport buffer		49	-	
	Connect tubing to calibration solutions		49	-	
	Connect waste line to waste container		49	-	

Step	Action	Chapter	Page	Figure	Check
5	Switch on device	7 Operation	79	-	
	Switch on power switch on back of device	7 Operation	79	-	
	Wait for internal computer to boot (white LED turns red)				
6	Start PC software	7 Operation	79	Figure 70	
	Double click „Start“ icon on desktop (trace_mon)		79	Figure 70	
	Wait for automatic connection setup or connect device	7 Operation and 7.2.2.1 Connect	79-88ff	Figure 81	
	Start with selecting “new tubing set”		88	Figure 82	
7	Set operating parameters	7.2.4 Menu item „Settings“	93ff	Figure 87	
	Basic settings	7.2.4.3 Basic settings	99ff	Figure 94	
	Select measuring method (filtration or dialysis)		99ff	Figure 94	
	<b>M4 only:</b> define as connected peripheral		100	Figure 95	
	Measurement parameters	7.2.4.1 Parameters	94ff	Figure 88- Figure 89	
	Set measurement period		94	Figure 88	
	Enter calibration standard values		94	-	
	Create file for saving measured values	7.2.1 Menu item „Log“	87	Figure 79	
8	Connect sampling probe(s)				
	Connect dialysis probe to tubing	6.2.7.5 Connecting the dialysis probe to the tubing set	64	Figure 57	
	Connect filtration probe to tubing	6.2.8.4 Connecting the filtration probe to the tubing set	70	Figure 62	
	Connect bypass module to tubing	6.2.9 Connecting the bypass module	70		
9	Start the measurements	7 Operation	79	Figure 70	
	Confirm “Fill” button and wait for calibration		81	Figure 72	
	Alternatively: Activate “Start automatically”		81	Figure 72	
10	<b>For methanol / ethanol only:</b> Connect enzyme reactor	6.2.6 Connection and removal of the enzyme reactor	58	Figure 48	
	Install enzyme reactor into tubing set		59	Figure 48	
11	Check measuring chamber	5.3 Measurement cell function	40	-	
	Abbsence of air bubbles		40	Figure 18	
12	<b>For dialysis only:</b> Perform reference measurement	7 Operation	79	Figure 74- Figure 78	
	Perform reference measurement with external sample or known measurement value	7.1.5 Reference (for dialysis only)	82ff	Figure 74- Figure 78	
	<b>For M4 only:</b> Autoreference of all 4 ports possible	7.2.5.2 Autoreference (Dialysis mode only)	104	Figure 100	
13	Optional: Connect analog output to process control system	6.6 Assignment of analog outputs	76	Figure 68	
	Connect analog output (0 – 10 V, 4 – 20 mA resp. 0 – 20 mA)		76	Figure 68	

Table 13: Checklist for Setting-up operation



## 9 Troubleshooting

If the device cannot be started up or malfunctions occur while running operations, then it is generally best to call upon experienced users for maintenance and / or the manufacturer's service technicians for repairs.

	<p>To avoid life-threatening hazards from an electric shock,</p> <ul style="list-style-type: none"> <li>• work on the electrical equipment must only be carried out by qualified and authorized experts!</li> <li>• you shall only try to remedy malfunctions that are obviously attributable to operating or servicing errors yourself!</li> <li>• under no circumstances shall you try to troubleshoot any problems with electrical equipment!</li> </ul>
---	---

If you have problems with the device, start by consulting Table 14: Problem description and troubleshooting" (page 127) and Table 15: Identifying and correcting calibration faults" (page 128) . They contain an overview of potential malfunctions.

### 9.1 Error messages

The device has some internal tests and gives appropriate error messages. The acknowledgment by the "ok" button closes these messages. As long as the error is not resolved, corresponding marks  and  appears on the control.

Pressing on these markers, the error messages can be opened again. If the error is resolved, the messages and marks will be removed.

#### 9.1.1 Calibration error

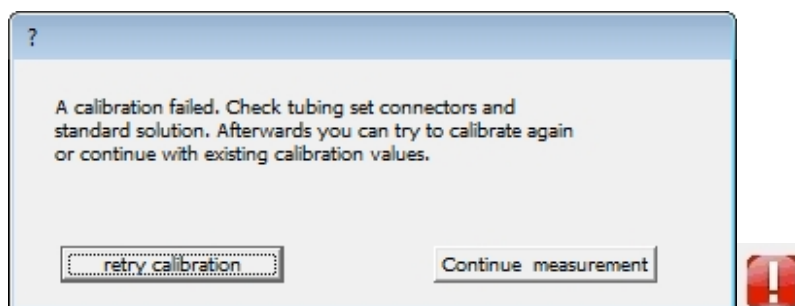

For each calibration, the resulting measurements must lie within given tolerances, otherwise this error message appears. Table 14 and Table 15 give an overview of possible causes and repair.

### 9.1.2 Calibration implausible

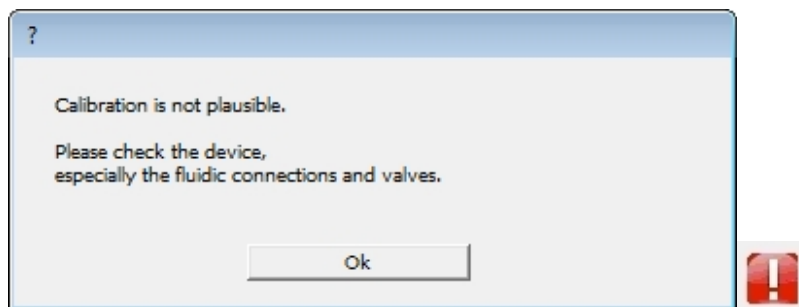

This test is a plausibility check, in which, although the calibration run smoothly, false results occur (for instance if the standard concentrations typed in wrong). For each calibration, the resulting values (offset / slope) must lie within given ranges, otherwise this error message appears. Table 14 and Table 15 give an overview of possible causes and repair.

### 9.1.3 Sensor error

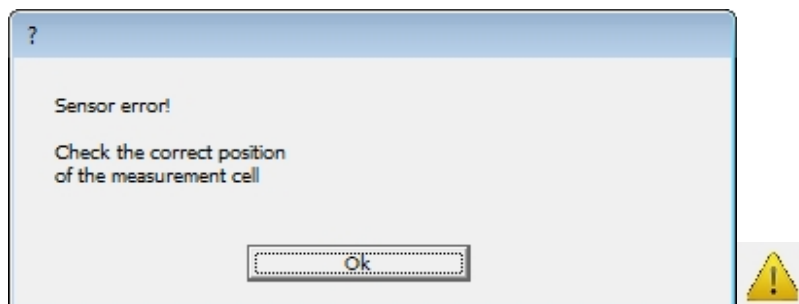

The device is automatically monitoring if the pin connectors have electrical contact to the measurement cell. If this is not the case, erroneous readings may result. Please check whether the cell has been inserted correctly.

### 9.1.4 Error in control

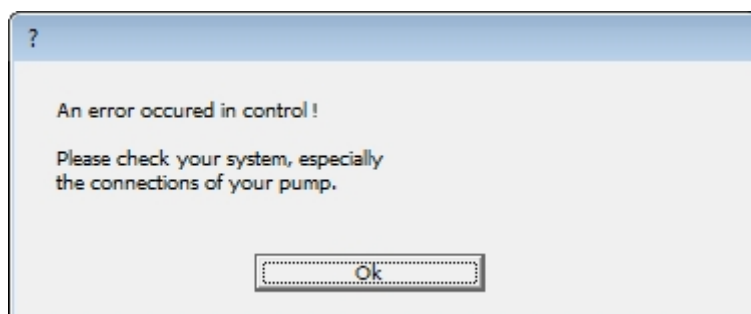

This message appears if the communication with an external digital pump is disturbed.



Error / Error message	Possible causes
Calibration failed	"Standard" parameter entry and actual standard do not match Calibration standard empty Transport buffer empty Probe connecting line left open Air bubble inside the measuring chamber Incorrect tubing set used Measurement cell not properly inserted Wrong method selected Valve tubes inserted incorrectly or not inserted Dialysis only: Three-way stopcock incorrectly adjusted Tubing set out of date Leaks in the tubing set Calibration line blocked or tubing set clogged Software versions of device   PC not compatible Valve (yellow) cannot be triggered
Measured value too high or too low	Dialysis only: Reference measurement not performed Dialysis only: Reference measurement not up-to-date Calibration erroneous Air bubble inside the measuring chamber Transport buffer empty Leaks in the tubing set
No or negative measured value	Measurement cell not properly inserted Transport buffer empty Tubing set clogged Leaks in the tubing set Tubing set out of date No sampling probe or wrong sampling probe connected
Measured value varies greatly	Air bubble inside the measuring chamber Measurement cell not properly inserted Tubing set out of date Filtration sampling probe sealed and   or green valve of valve tube not properly inserted
No connection to trace_mon	IP address set incorrectly PC: IP address not automatically assigned Incorrect or defective power cord Device boots but program does not start
Pump is not turning	Pump cassette defect / remove pump cassette and clean motor shaft, pull tight pump tube
No flow	Transport buffer empty Calibration standard empty Filtration probe blocked Filter clogged Tubing set clogged Leaks in the tubing set

Table 14: Problem description and troubleshooting

Error message: **Calibration failed**

Possible causes	What should you do?
1. The transport buffer is empty (Is there still enough transport buffer in the storage vessel? Is the suction tubing still in the storage vessel? Is buffer dripping into the drip counters?).	Connect new transport buffer and fill the tubing set.
2. A calibration solution is empty.	Connect new calibration solution.
3. Dialysis: Probe connecting lines are open.	Close probe connecting line or connect dialysis probe.
4. Silicone tubes are not properly inserted into the valves.	Check if the valve tubes are secure and correct accordingly.
5. An air bubble is inside the measuring chamber.	Restart the device and start priming again.
6. Tubing set and adjusted application do not match (e.g. dialysis tubing set and filtration is adjusted at the device).	Adjust application properly.
7. A tube is pinched (e.g. when screwing the covers in the standard bottles).	Remove pinch.
8. There is clogging in the tubing set (When the buffer remains in the tubing set over an extended period of time, salts begin to crystallize. Crystallization usually occurs on the silicone tubes in the valves. Clogging can also occur due to microbial growth).	Remove clogging. If this is not possible, use a new tubing set.  Check waste line for kinks or pinches!
9. Leaks (If the clog is not removed, tubes may burst).	Correct leaks. If this is not possible, use a new tubing set.
10. Sensor does not have proper contact (When the sensor is not inserted properly, the reverse side of the sensor does not have proper electrical contact with the sensor holder.)	Remove sensor and reinstall it properly.
11. The dialysis membrane was installed in the probe in the incorrect position (only for DIALYSIS application).	Correctly install a new dialysis membrane into the probe.
12. Three-way stopcock was not properly adjusted (only for DIALYSIS application. An external sample was measured and the three-way stopcock was not reset).	Adjust the three-way stopcock to the correct position.
13. The software versions of the device and the PC are not compatible.	Use suitable software. If necessary, reinstall the PC software trace_mon from the website.

Table 15: Identifying and correcting calibration faults

## 10 Care and maintenance

### 10.1 Device

It is recommended to examine the device periodically to the following points and, if necessary, take steps to service.

Tasks:

1. Cleaning of the surface of the housing (wet)
2. Cleaning of the motor shafts (dry)
3. Cleaning the sensor contacts (dry)
4. Functional verification of valves and motors



The surface of the device housing should only ever be cleaned with a wet cloth.

### 10.2 Tubing set cleaning

Clogged or damaged tubing sets must be replaced with new ones.

If a measurement series is interrupted for a short time (maximum of two days), the system can continue to be operated without replacing the tubing set. A prerequisite is that the system was kept in the standby mode and all tubes were in contact with liquid.

For longer waiting times the cleaning mode (see chapter "7.2.2.3 Cleaning") should be used. For this purpose, all of the lines of standards and transport buffer, and optionally the filtration line have to be connected to the cleaning solution (Order No. 850.300.710/850.300.711).

For a new start, you must go to the menu item "Setting-up operation" and this procedure requires that the tubing system is re-primed (with transport buffer!).

Cleaning procedure:

1. Fill 250 ml of the cleaning solution in a vessel.
2. All open lines of the tubing set (buffer, standard 1, standard 2) have to be immersed in the cleaning solution.
3. Method dialysis: If possible leave the tubing connected to the probe while cleaning. If not possible (e.g. due to post-process heat sterilisation) remove the Luer connections from the dialysis probe and join them together. In this case the Luer-UNF Adapter lines have to be disinfected and flushed separately!

4. Method filtration: Remove the tubing connection from the filtration probe and immerse it also in the cleaning solution.
5. Method methanol/ethanol: Remove the enzyme reactor and store it in transport buffer at 2-8°C.
6. Start the cleaning procedure with "Cleaning" (see chapter "7.2.2.3 Cleaning").

The device is then allowed to run until the cleaning solution has been used up. Then the process is repeated with 1 L of demineralized water. By this measure, the tubing set is disinfected with the cleaning solution and then freed of residual salts in the tubes.

If the tubeset remains unused for more than 2 days in the purified state, it is advisable to remove the silicone tubes from the valve slots in order to prevent sticking of the hoses.

To recommissioning of the tubing set the tubes need to be properly inserted again. Then, a priming procedure with transport buffer is necessary.

If the device is to be decommissioned for longer periods of time, the tubing set shall be replaced upon recommissioning.



If salt remains in the tubeset, it will cause blockages. This will result in incorrect readings or leaks when reusing the set.



The UNF-Luer adapter lines can cause a tubeset/probe contamination / clogging during the next run if not properly disinfected and flushed similar to the tubeset.



Before every startup of the system, check all connections made with LUER lock or UNF fittings for any leaks. Clean and tighten them as necessary.

## 11 Disposal

### 11.1 General instructions

#### Packaging

The packaging is made of environmentally friendly materials that can be used as secondary raw materials. If the packaging is no longer needed, it can be disposed of by local waste disposal authorities.

#### Device

The device including accessories does not belong in your regular household waste as this equipment is manufactured from high-grade materials which can be recycled and reused. European Directive 2002/96/EC on Waste Electrical and Electronic Equipment (WEEE) requires that electrical and electronic equipment be collected and disposed of separately from other unsorted municipal waste, with the aim of recycling it.

	The crossed-out waste bin symbol indicates that separate collection is required.
---	--

### 11.2 Hazardous Materials

The device does not contain any hazardous materials that would necessitate special disposal measures.

The cultures and solutions (e.g. acids, bases) used during the fermentation processes are potentially hazardous materials that could cause biological or chemical hazards.

Devices contaminated with hazardous materials (NBC-contamination) will not be accepted for repair or disposal.

#### **Note in accordance with European directive on hazardous substances!**

According to the EU directives, the owners of devices that come into contact with hazardous substances are responsible for properly disposing of these devices and to declare such devices when transporting them.

#### **Decontamination Declaration**

TRACE Analytics GmbH has a duty to protect its staff from hazardous substances. When returning devices and device components, the sender must enclose a decontamination declaration as proof of compliance with the safety regulations governing the area of application for which they were used.

- This declaration must detail the microorganisms, cells and media that the device has come into contact with and the measures taken to disinfect and decontaminate it.
- The recipient must be able to read this decontamination declaration before opening the packaging.

The form of a decontamination declaration is included in the appendix „Decontamination Declaration“ and on the website of TRACE Analytics at [www.trace.de](http://www.trace.de).

**Danger of injury from work performed incorrectly!**

The disassembly and disposal of the device may only be carried out by technical personnel.

## 12 Appendix

### 12.1 Technical documentation

The operating manuals contain the instructions for operating the devices with the standard equipment intended for this purpose.

The scope of the delivery may not contain all of the equipment described in this document. Where custom-made, devices may also contain modified or additional parts. Please refer to the order or delivery documents for detailed information on the device specifications and the scope of the delivery as contractually agreed or as supplied with the device.

If the documents supplied do not match the equipment delivered to you or if any documents are missing, please contact the person responsible for your area or get in touch directly with TRACE Analytics or an authorized distributor.

## 12.2 Specifications (Technical data sheet)

Measuring principle	Enzymatic-amperometric
Measuring range (glucose)	0.10 – 40 g/l
Measuring range (lactate)	0.05 – 5 g/l
Measuring range (methanol)	0.5 – 20 g/l
Measuring range (ethanol)	1 – 40 g/l
Measuring frequency	Up to 60 measurement values/h
Measurement deviation (glucose)	≤ 1,5 % at 2.0 g/l
Measurement deviation (lactate)	≤ 1,5 % at 1 g/l
pH-range of the medium	4.8 – 9.2
Service life of the enzyme electrode	30 days or 5000 analysis
Maximum flow rate feed pump	4.9 ml/ min
Ambient temperature	15 – 35 °C
Ambient humidity	10 – 90 %
Interfaces	RS 232, Ethernet, OPC UA, Modbus TCP
PC for control	Operating system Windows XP, 7, 8, 10, Windows Server 2012 R2
Analog output	0..10 V / 0..20 mA / 4..20 mA
Input voltage	100..120 / 220..240 V ~; 50/60 Hz
Storage battery (1x Lithium metal battery)	Type CR2430 (3V, 270 mAh); Lithium content per cell 0,09 g, UN test 38.3
Dimensions in mm (WxHxD)	120 x 170 x 200
Weight	1.8 kg

Table 16: Technical data sheet TRACE C2 Control

Ambient temperature	15 – 35 °C
Ambient humidity	10 – 90 %
Interfaces	Ethernet
PC for control	Operating system Windows XP, 7, 8, 10, Windows Server 2012 R2
Input voltage	100..120 / 220..240 V ~; 50/60 Hz
Storage battery (1x Lithium metal battery)	Type CR2430 (3V, 270 mAh); Lithium content per cell 0,09 g, UN test 38.3
Dimensions in mm (WxHxD)	120 x 170 x 200
Weight	1.8 kg

Table 17: Technical data sheet TRACE M4



## **12.3 Additional Documentation**

### **12.3.1 EC Declaration of Conformity**

With the attached declaration of conformity TRACE Analytics GmbH confirms the compliance of the devices TRACE C2 Control and TRACE M4 with the directives cited.

### **12.3.2 Decontamination Declaration**

When returning equipment, copy and carefully complete this pre-printed form as required, and enclose it with the delivery documents.

The recipient must be able to inspect the completed declaration before removing the device from the packaging.

## Index

Analog outputs.....	76
Autoreference .....	104
Basic settings .....	99
Biosensor .....	18
Bypass module.....	44
Calibration .....	82
Calibration history .....	92
Calibration values .....	91
Checklist .....	123
Contamination.....	115
Controller.....	105
Dialysis probe .....	42
Enzyme reactor .....	19, 46
Error messages .....	125
Events .....	101
Excel .....	118
External sample .....	84
Filtration probe .....	43
Frequency.....	94
IP address .....	71
Ip_set.....	72
Language.....	100
LED signals .....	112
Macro .....	118
Measurement period.....	94
Network settings .....	72
OPC UA Server .....	97
Parameters .....	94
Password .....	72
Peripherals.....	100
PID-controller .....	21, 107
priming .....	80
Probes	
Bypass module .....	44
Dialysis.....	42
Filtration.....	43
Reference .....	82
Schedule.....	101
Serial interface .....	96
Start settings .....	75
Test ports .....	98
Tips.....	114
Tubing set for M4 .....	56
Tubing set installation.....	51
Workflow .....	103